

# Installation Manual

## IX Series

### Networked Video Intercom System

**IX-DV, IX-DVF, IX-DVF-P, IX-DVF-2RA, IX-DVF-RA, IX-DVF-L,  
IX-SSA, IX-SSA-2RA, IX-SSA-RA**

---

#### Introduction





- Read this manual before installation and connection. Read the "Setting Manual" and "Operation Manual". The manuals can be downloaded from our homepage at "<https://www.aiphone.net/support/software-document/>" free of charge.
- After completing installation and connection, program the system according to the "Setting Manual". The system cannot operate unless it is programmed.
- After performing installation, review with the customer how to operate system. Leave documentation accompanying the Master Station with the customer.



- Perform installation and connection only after gaining sufficient understanding of the system and this manual.
- The illustrations used in this manual may differ from the actual stations.

## Literature information

The important information concerning correct operation and what you should observe is marked with the following symbols.

 <b>Warning</b>	This symbol means that operating the device incorrectly or ignoring these precautions may cause severe injury or death.
 <b>Caution</b>	This symbol means that operating the device incorrectly or ignoring these precautions may cause severe injury or property damage.
	This symbol is intended to alert the user to prohibited actions.
	This symbol is intended to alert the user to important instructions.

## Precautions



### Warning

**Negligence could result in death or serious injury.**



**Do not disassemble or modify the station.**

This may result in fire or electrical shock.



**Do not use with a power supply voltage above the specified voltage.**

This may result in fire or electrical shock.



**Do not install two power supplies in parallel to single input.**

Fire or damage to the unit could result.



**Do not connect any terminal on the unit to AC power line.**

Fire or electric shock could result.



**For power supply, use Aiphone power supply model specified for use with system.**

If non-specified product is used, fire or malfunction could result.



**Do not, under any circumstances, open the station.**

Voltage within some internal components may cause electrical shock.



**The device is not designed to explosion-proof specifications. Do not install or use in an oxygen room or other such locations filled with volatile gases.**

May cause fire or explosion.



### Caution

**Negligence could result in injury to people or damage to property.**



**Do not install or connect the device with the power on.**

May cause electrical shock or malfunction.



**Do not turn on power without first checking to make sure the wiring is correct and there are no improperly terminated wires.**

This may result in fire or electrical shock.



**Do not put your ear close to the speaker when using the station.**

May cause harm to the ear if a sudden loud noise is emitted.

## General Precautions

- Install low-voltage lines at least 30cm (11") away from high-voltage lines (AC100V, 200V), especially inverter air conditioner wiring. Failure to do so may result in interference or malfunction.
- When installing or using the station, give consideration to the privacy rights of subjects, as it is the responsibility of the system owner to post signs or warnings in accordance with local ordinances.

## Notice

- If the station is used in areas where there are business-use wireless devices such as a transceiver or mobile phones, it may cause malfunction.
- If the device is installed close to a light dimmer, an inverter electrical appliance or the remote control unit of a hot-water system or floor-heating system, it may create interference and cause a malfunction.
- If the device is installed in an area with an extremely strong electrical field, such as in the vicinity of a broadcasting station, it may create interference and cause a malfunction.
- If warm air from inside the room enters the unit, the internal and external temperature difference may cause condensation on the camera. Plugging of cable holes and other gaps where warm air might enter is recommended for preventing condensation.

## Precautions for mounting

- If installed in the place where the sound is easy to echo, it may be difficult to hear the conversation with echoed sounds.
- Installing the device in locations or positions such as the following may affect the clarity of the image:
  - Where lights will be shining directly into the camera at night time
  - Where the sky fills much of the background
  - Where the background of the subject is white
  - Where sunlight or other strong light sources will shine directly into the camera

Where the sky fills much of the background

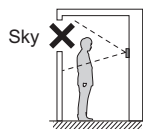

Where the background of the subject is white

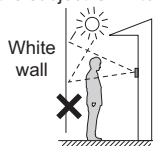

Where sunlight or other strong light sources will shine directly into the camera



- In 50Hz regions, if a strong fluorescent light shines directly into the camera, it may cause the image to flicker. Either shield the camera from the light or use an inverter fluorescent light.
- Installing the device in the following locations could cause malfunction:
  - **Locations near heating equipment**  
Close to a heater, boiler, etc.
  - **Locations subject to liquid, iron filings, dust, oil, or chemicals**
  - **Locations subject to moisture and humidity extremes**  
Bathroom, basement, greenhouse, etc.
  - **Locations where the temperature is quite low**  
Inside a cold storage warehouse, the front of a cooler, etc.
  - **Locations subject to steam or oil smoke**  
Next to heating devices or a cooking space, etc.
  - **Sulphurous environments**
  - **Locations close to the sea or directly exposed to sea breeze**
- If existing wiring is used, the device may not operate properly. In that case, it will be necessary to replace the wiring.
- Do not, under any circumstances, use an impact driver to fasten screws. Doing so may cause damage to the device.

# Table of contents

Literature information .....	1
Precautions .....	1
Example of System Configuration.....	4
Part Names and Accessories.....	4
Part Names .....	4
Included accessories .....	7
IX-DV .....	7
IX-DVF, IX-DVF-P, IX-DVF-2RA, IX-DVF-RA, IX-DVF-L, IX-SSA, IX-SSA-2RA, IX-SSA-RA .....	7
Status Indicator .....	8
How to Install .....	8
HID reader Installation (IX-DVF-P only) .....	8
Video Door Station Installation .....	9
IX-DV (surface mount) .....	9
IX-DVF, IX-DVF-P, IX-DVF-2RA, IX-DVF-RA, IX-DVF-L, IX-SSA, IX-SSA-2RA, IX-SSA-RA (flush mount) .....	10
Camera View Area and Mounting Location (IX-DV, IX-DVF, IX-DVF-P, IX-DVF-2RA, IX-DVF-RA, IX-DVF-L) .....	11
Camera view adjustment .....	11
Camera view range .....	11
How to Connect .....	12
Connection Precautions .....	12
Cat-5e/6 cable .....	12
Precautions regarding low-voltage line .....	12
Wiring Connection.....	13

# Example of System Configuration

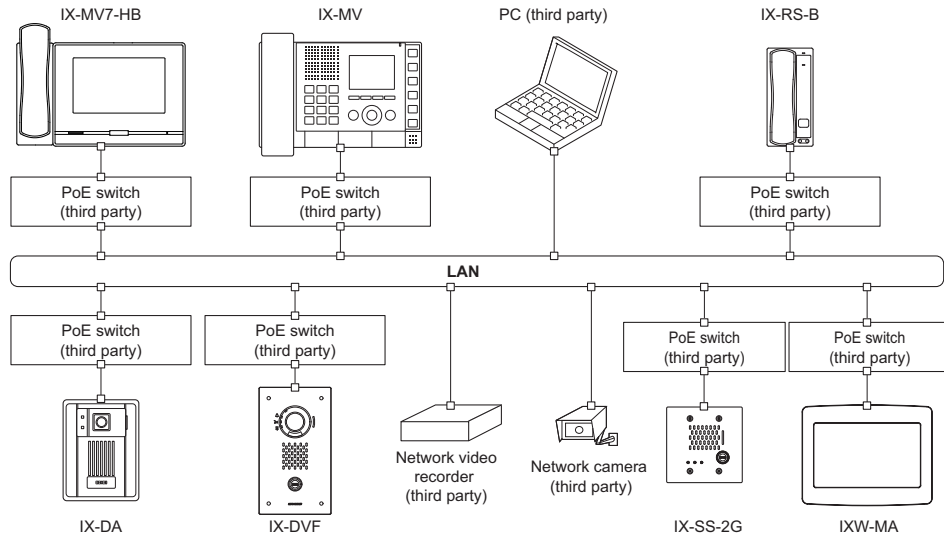

## Part Names and Accessories

### ■ Part Names

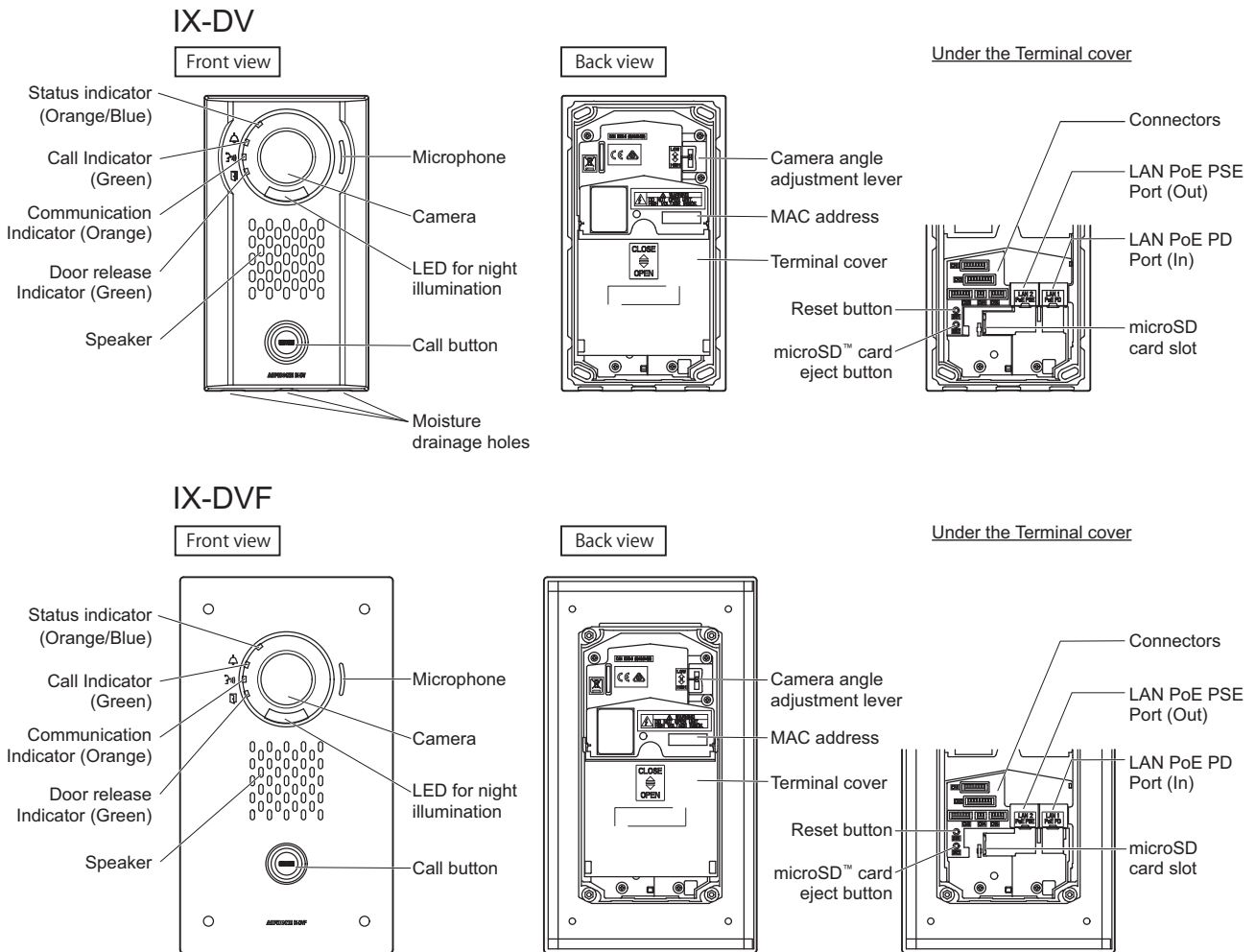

## IX-SSA

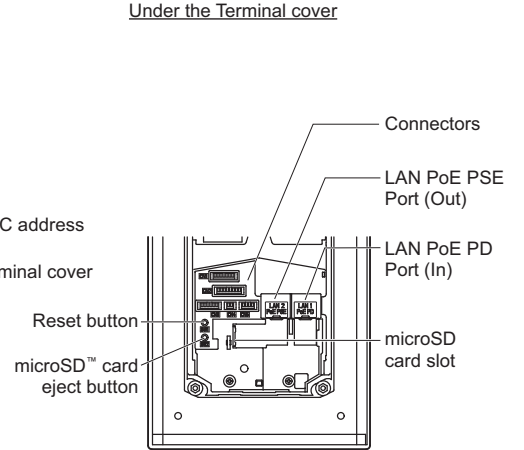
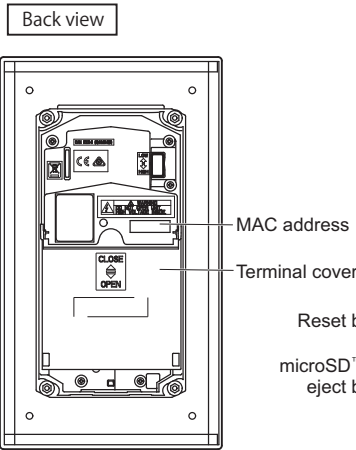
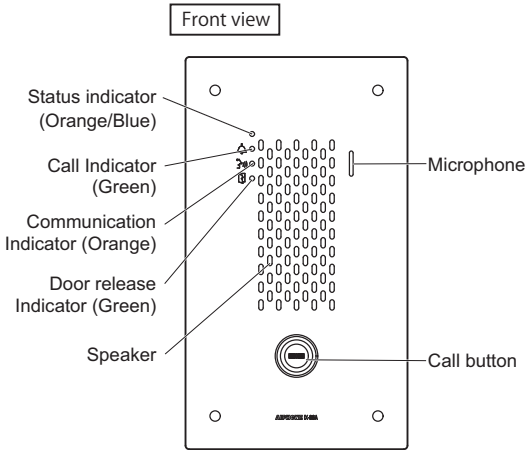

## IX-DVF-2RA

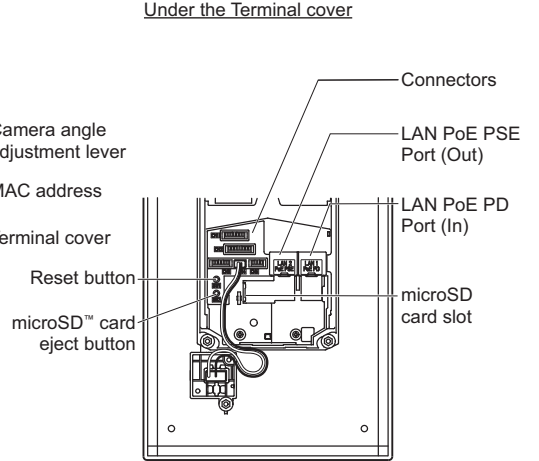
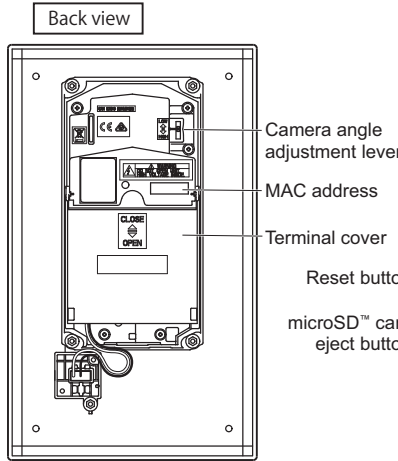
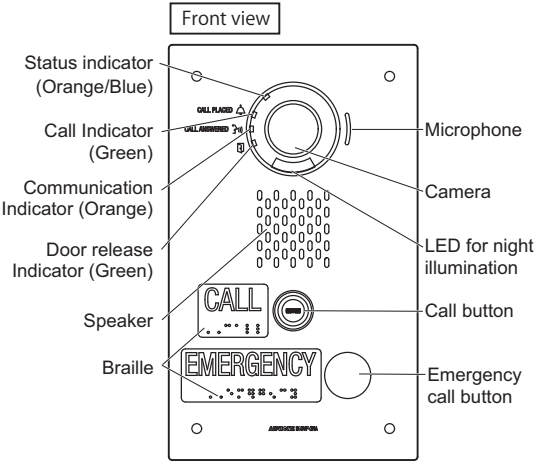

## IX-DVF-RA

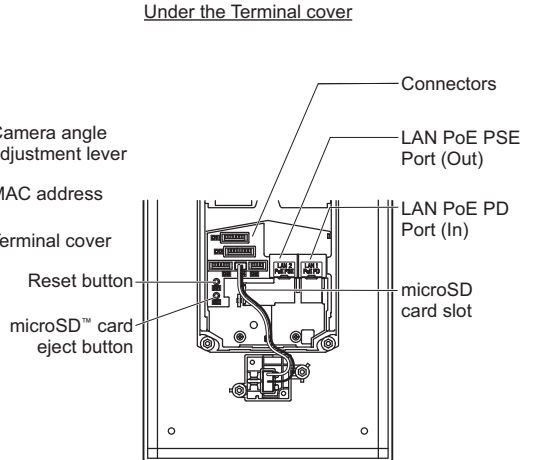
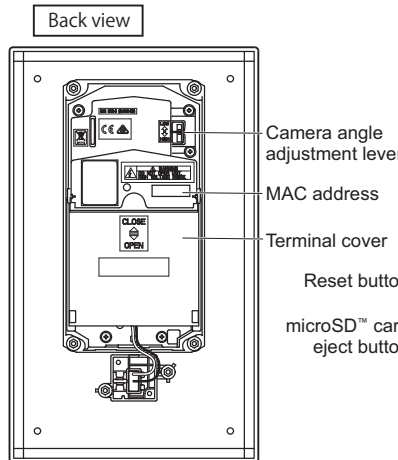
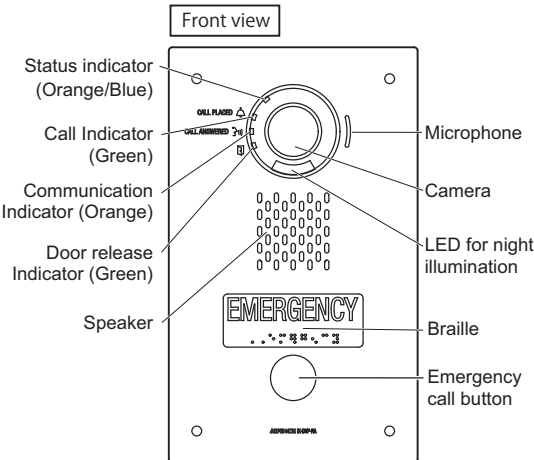

## IX-DVF-P

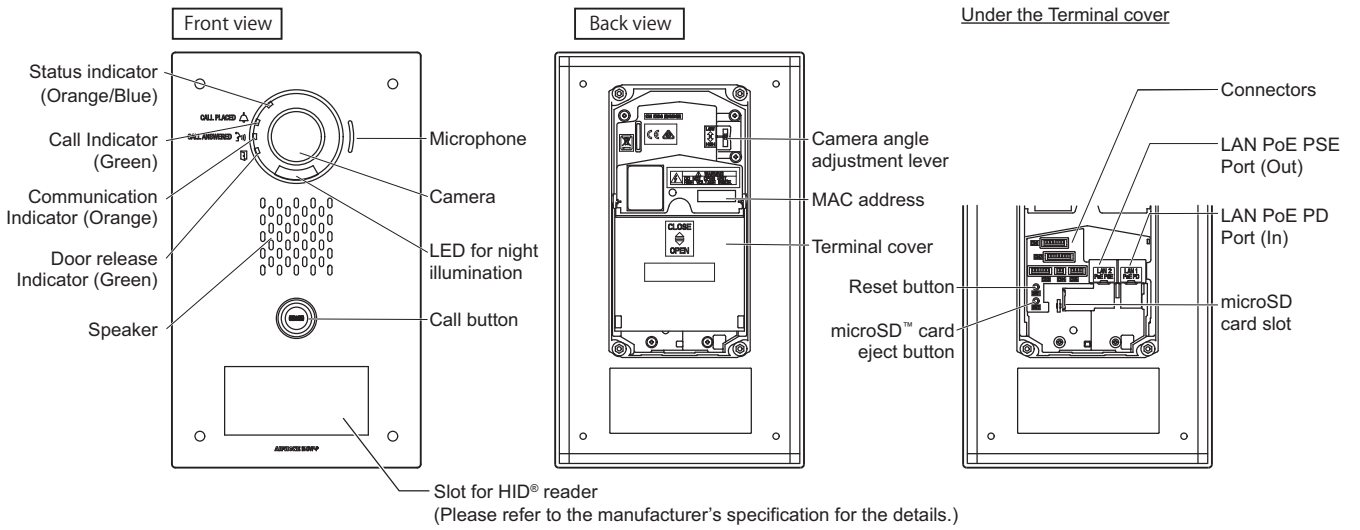

## IX-DVF-L

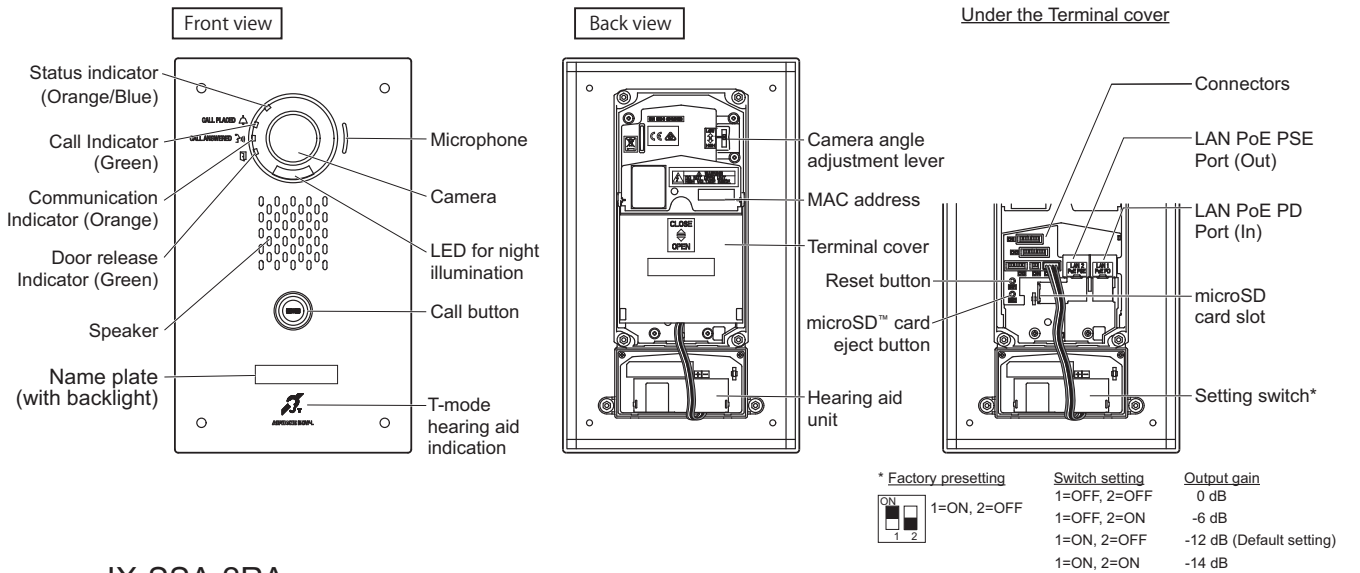

## IX-SSA-2RA

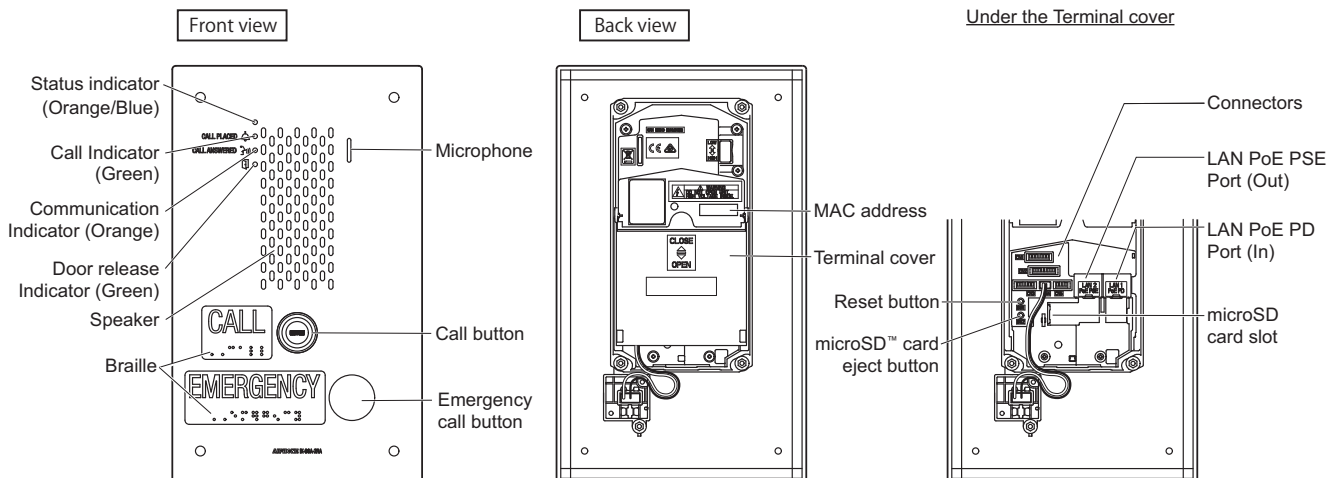

# IX-SSA-RA

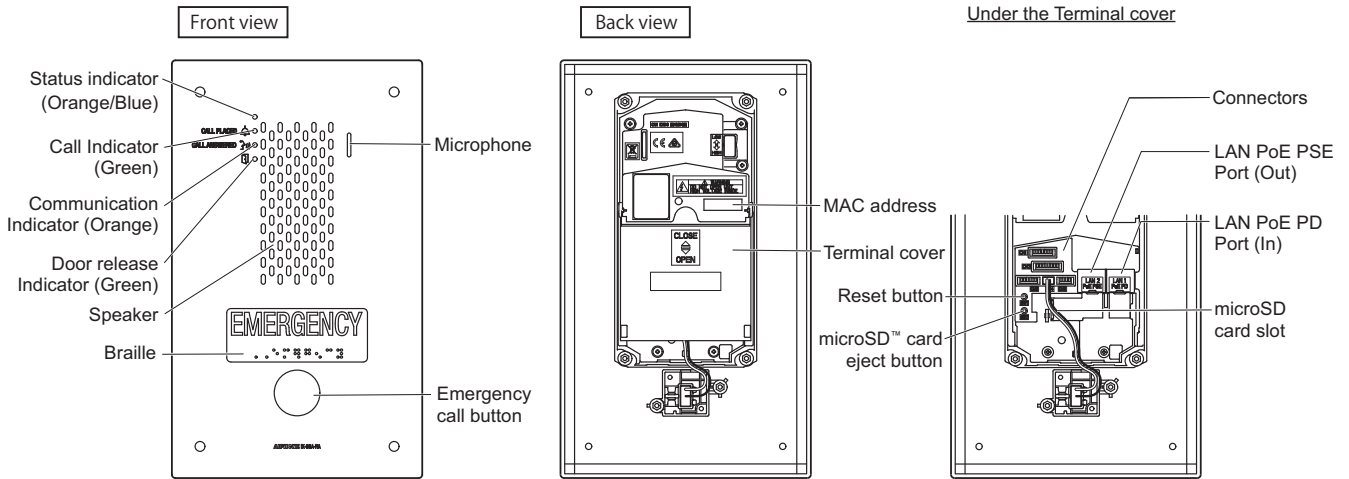

## ■ Included accessories

### ● IX-DV

	Anchors x 4 	Wall-mounting screws x 4 	Special screwdriver x 1 
	Installation Manual x 2 (English, French) 	Notice (IX Manuals and Software) x 1 	Option connectors (6pin x 1, 7pin x 1, 8pin x 1) 
	Ferrite cores x 2 	Chinese RoHS declaration x 1 	

### ● IX-DVF, IX-DVF-P, IX-DVF-2RA, IX-DVF-RA, IX-DVF-L, IX-SSA, IX-SSA-2RA, IX-SSA-RA

	Back box x 1 	Special screws x 4 	Special screwdriver x 1 
	Installation Manual x 2 (English, French) 	Notice (IX Manuals and Software) x 1 	Option connectors (6pin x 1, 7pin x 1, 8pin x 1) 
	Ferrite cores x 2 	Transparent name plates x 2 (IX-DVF-L only) 	Chinese RoHS declaration x 1 
	HID® reader mounting kit (Mounting bracket x 1, nut x 2, washer x 2, mounting screw x 2) (IX-DVF-P only) 		



# Status Indicator

Refer to "Operation Manual" for additional indicators not listed.

☀: Lit □: Off

Status (Pattern)		Meaning
Orange flashing	Normal flashing ☀ 0.75 sec → □ 0.75 sec	Booting
	Rapid flashing ☀ 0.25 sec → □ 0.25 sec	Device error
	Long interval flashing ☀ 0.5 sec → □ 4 sec	Communication failure
	Long irregular flashing ☀ 1 sec → □ 0.25 sec → ☀ 0.25 sec → □ 0.25 sec → ☀ 0.25 sec → □ 0.25 sec	Firmware version updating
	Long irregular flashing ☀ 2 sec → □ 0.25 sec → ☀ 0.25 sec → □ 0.25 sec	Mounting micro SD card, unmounting micro SD card
	Long irregular flashing ☀ 1 sec → □ 0.25 sec → ☀ 0.25 sec → □ 0.25 sec	Initializing
Blue light	☀	Standby

## How to Install

### ■ HID reader Installation (IX-DVF-P only)

\* Use the short 6-32 × 1/4" philips head screw (included with HID reader).

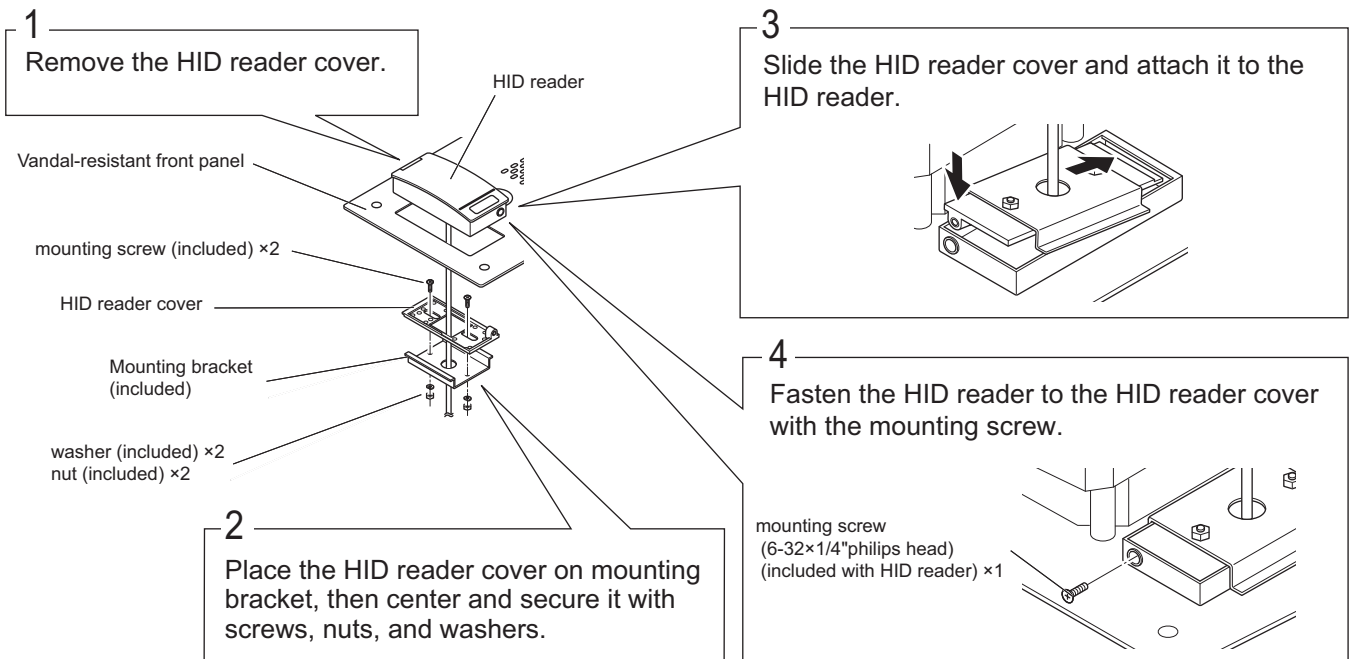

# ■ Video Door Station Installation

## ● IX-DV (surface mount)

**!** • The installation height of the equipment should not exceed more than 2m (Upper Edge) from the ground level.

**1**

Loosen the screw with the special screwdriver, and remove the front cover.

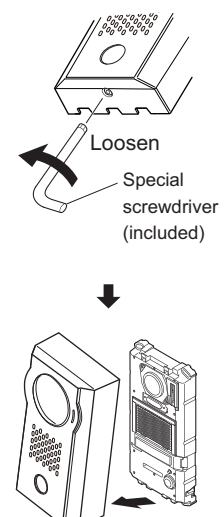

Loosen

Special screwdriver (included)

Tighten

**4**

Fasten the unit to the mounting surface.

\* Use anchors or concrete plugs as needed.

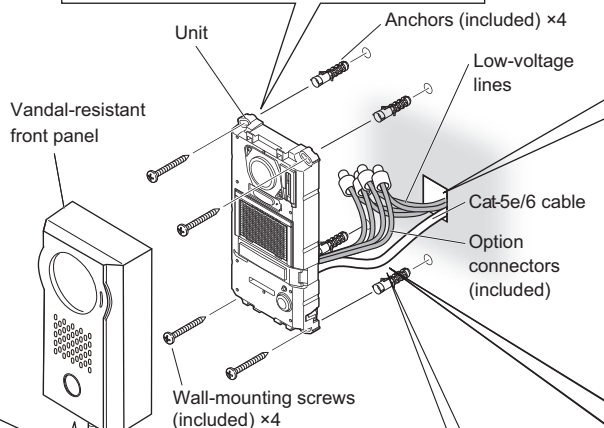

Unit

Anchors (included) ×4

Low-voltage lines

Cat-5e/6 cable

Option connectors (included)

Wall-mounting screws (included) ×4

Vandal-resistant front panel

**NOTE**

Make room for threading a screw.

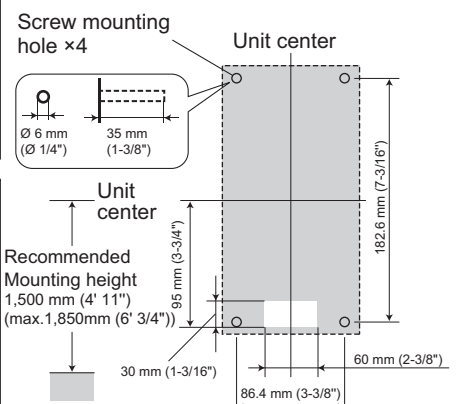

Screw mounting hole ×4

Unit center

Ø 6 mm (Ø 1/4")

35 mm (1-3/8")

182.6 mm (7-3/16")

95 mm (3-3/4")

Recommended Mounting height 1,500 mm (4' 11") (max. 1,850mm (6' 3/4"))

30 mm (1-3/16")

86.4 mm (3-3/8")

60 mm (2-3/8")

**2**

Open the terminal cover, and join the option connectors (included) to the low-voltage lines, and insert the option connectors and Cat-5e/6 cable to the unit.

- (1) Slide the terminal cover down.
- (2) Open up the terminal cover.
- (3) Insert the option connectors and Cat-5e/6 cable to the unit, and replace the terminal cover.

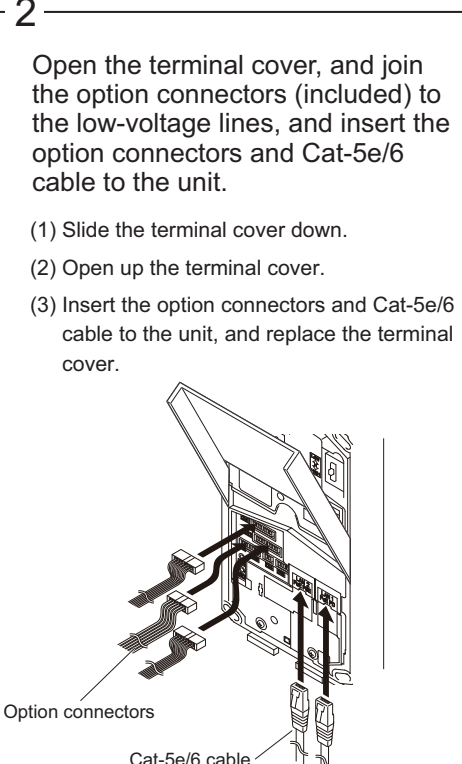

Option connectors

Cat-5e/6 cable

**5**

Attach the front cover to the unit by hanging the upper 2 clips on the unit.

\* Tighten the screw with the cover pressed to the wall.

**3**

Clamp the ferrite cores to Cat-5e/6 cables.

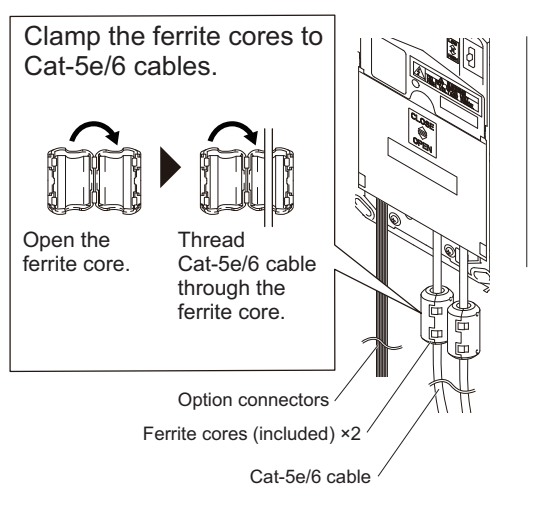

Open the ferrite core.

Thread Cat-5e/6 cable through the ferrite core.

Option connectors

Ferrite cores (included) ×2

Cat-5e/6 cable

**!** Be sure to close the terminal cover when done. If left open, condensation or water may enter, preventing heat dissipation and causing damage.

● IX-DVF, IX-DVF-P, IX-DVF-2RA, IX-DVF-RA, IX-DVF-L, IX-SSA, IX-SSA-2RA, IX-SSA-RA (flush mount)

**!** When installing the unit on a rough surface, please use sealant to seal the unit edges to prevent water entering the unit. If the unit edges are left unsealed on a rough surface, IP65 ingress protection rating is not guaranteed.

**2**

Open the terminal cover, and join the option connectors (included) to the low-voltage lines, and insert the option connectors and Cat-5e/6 cable to the unit.

(1) Slide the terminal cover down.  
 (2) Open up the terminal cover.  
 (3) Insert the option connectors and Cat-5e/6 cable to the unit, and replace the terminal cover.

**!** Be sure to close the terminal cover when done. If left open, condensation or water may enter, preventing heat dissipation and causing damage.

Option connectors  
 Cat-5e/6 cable

**3**

Clamp the ferrite cores to Cat-5e/6 cables.

Open the ferrite core. Thread Cat-5e/6 cable through the ferrite core.

Option connectors  
 Ferrite cores (included) × 2  
 Cat-5e/6 cable

e.g.) IX-DVF-L

Back box (included)

148 mm \* (5-13/16")

267 mm \*\* (10-1/2")

60 mm (2-3/8")

Low-voltage lines

Transparent name plate (included in IX-DVF-L only)

Option connectors (included)

Vandal-resistant front panel with the unit attached

Special screws (included) × 4

Special screwdriver (included)

Loosen

Tighten

Back box

Wall

Min. 5 mm (3/16")

The back box must be installed at a depth of 5 mm (3/16") or more from the wall face.

Recommended Mounting height (box center)  
 1,500 mm (4'11")  
 (max. 1,850mm (6' 3/4"))

**5**

Fasten the front panel to the back box with the special screws.

(2) Fill in the name on the transparent name plate.  
 · Be sure to leave 25 mm (1") of white space on the right end to account for insertion.

(3) Insert the filled-in transparent name plate at the specified insertion opening (indicated with arrow to the right).

**4**

Insert the transparent name plate. (IX-DVF-L only)

(1) Peel off the protective plastic on the plate (both sides).

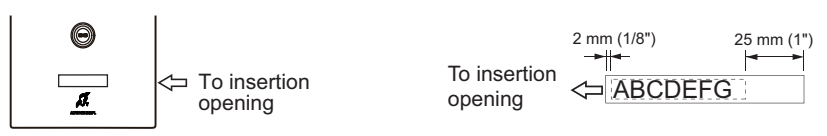

# ■ Camera View Area and Mounting Location (IX-DV, IX-DVF, IX-DVF-P, IX-DVF-2RA, IX-DVF-RA, IX-DVF-L)

## ● Camera view adjustment

Using the camera angle adjustment lever, the camera can be tilted up or down (-8°, 0°, +13°). Adjust the camera to the optimal position.

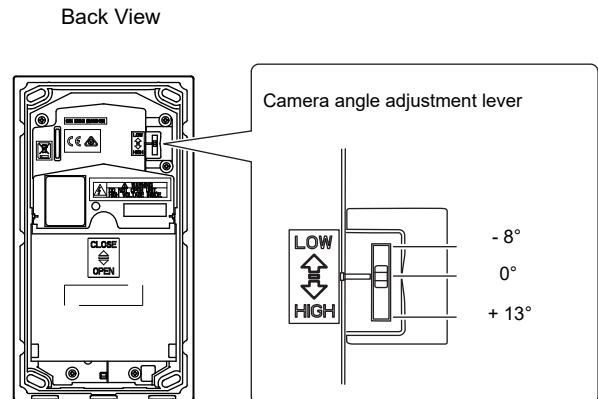

## ● Camera view range

The camera range as illustrated is only an approximate indication and may vary according to the environment.

### IX-DV, IX-DVF

Vertical

Camera angle 0°

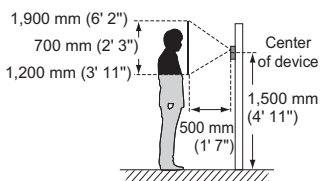

Camera angle 13°

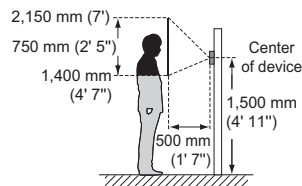

Camera angle -8°

(When the object position is lowered due to a stepped floor, etc.)

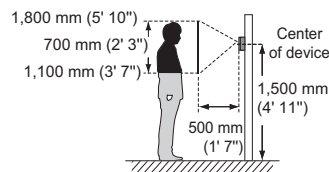

Horizontal

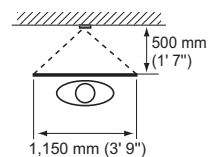

The dimensions are approximate in this page.

### IX-DVF-P, IX-DVF-2RA, IX-DVF-RA, IX-DVF-L

Vertical

Camera angle 0°

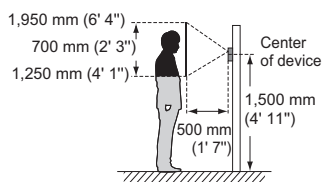

Camera angle 13°

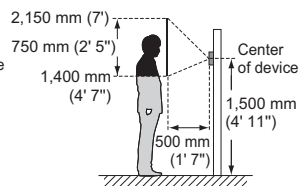

Camera angle -8°

(When the object position is lowered due to a stepped floor, etc.)

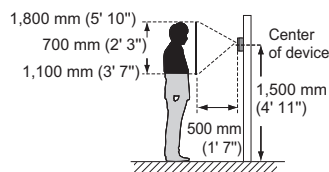

Horizontal

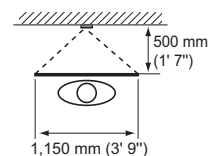

The dimensions are approximate in this page.

When light enters the camera, the monitor screen may flicker brightly or the subject may become dark. Try to prevent strong lighting from entering the camera directly.

# How to Connect

## ■ Connection Precautions

### ● Cat-5e/6 cable

- For connection between devices, use a straight-through cable.
- If necessary, when bending the cable, please observe the manufacturer's recommendations. Failure to do so could cause a communication failure.
- Do not strip away the cable insulation any more than is necessary.
- Perform termination in accordance with TIA/EIA-568A or 568B.
- Before connecting the cable, be sure to verify conduction using a LAN checker or similar tool.
- A RJ45 covered connector cannot be connected to the LAN ports of the master stations or the door stations. Use cables without covers on the connectors.



- Be careful not to pull on the cable or subject it to excessive stress.

### ● Precautions regarding low-voltage line

- Use PE (polyethylene)-insulated PVC jacketed cable. Parallel or jacketed conductors, mid-capacitance, nonshielded cable is recommended.
- Never use twisted-pair cable or coaxial cable.
- 2Pr quad V twisted pair cables cannot be used.

Parallel cable



Coaxial cable



- When connecting low-voltage lines, perform the connection using either the crimp sleeve method or soldering, then insulate the connection with electrical tape.

#### ● Crimp sleeve method

1. Twist the stranded wire around the solid wire at least 3 times and crimp them together.
2. Overlap the tape by at least a half width and wrap the connection at least twice.

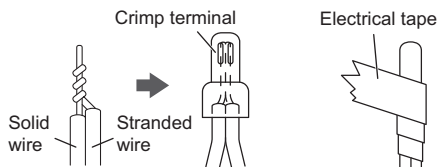

#### ● Soldering method

1. Twist the stranded wire around the solid wire at least 3 times.
2. After bending down the point, perform soldering, with care that no wires protrude from the soldering.
3. Overlap the tape by at least a half width and wrap the connection at least twice.

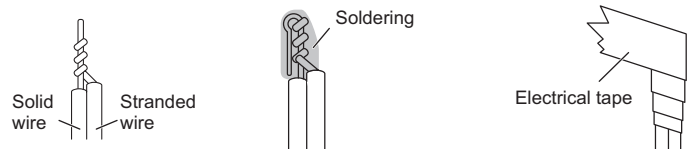

- If the connector-attached lead wire is too short, extend the lead with an intermediate connection.
- As the connector has polarity, perform the connection correctly. If the polarity is incorrect, the device will not operate.
- When using the crimp sleeve method, if the end of the connector-attached lead wire has been soldered, first cut off the soldered part and then perform crimp.
- **After completing connection of wires, check that there are no breaks or inadequate connections. When connecting low-voltage lines in particular, perform the connection using either soldering or the crimp sleeve method and then insulate the connection with electrical tape. For optimal performance, keep the number of wiring connections to a minimum.**

Simply twisting low-voltage lines together will create poor contact or will lead to oxidization of the surface of the low-voltage lines over long-term use, causing poor contact and resulting in the device malfunctioning or failure.

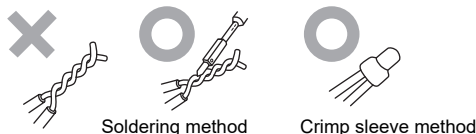

# Wiring Connection



- Insulate and secure unused low-voltage lines and the connector-attached lead wire.

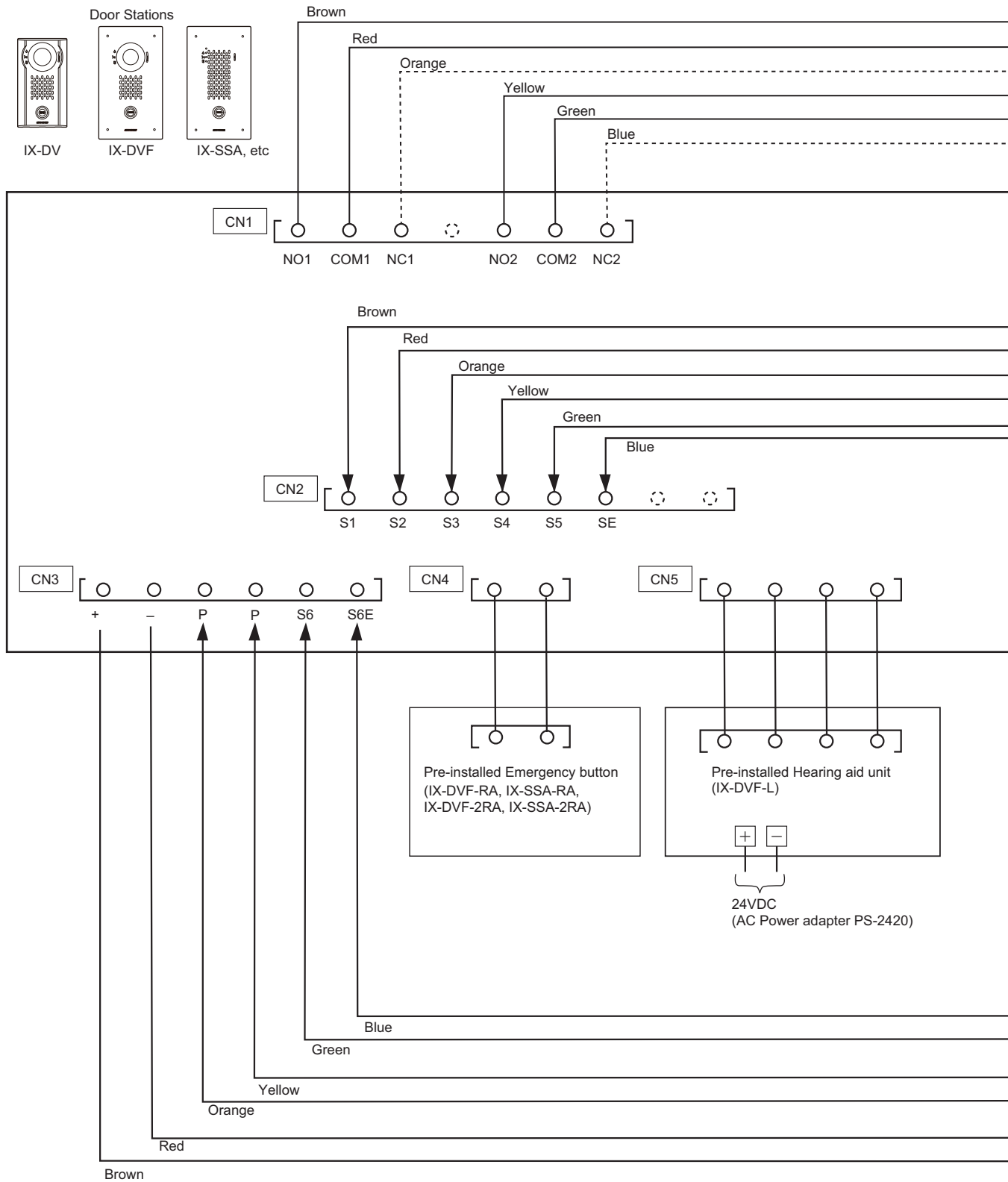

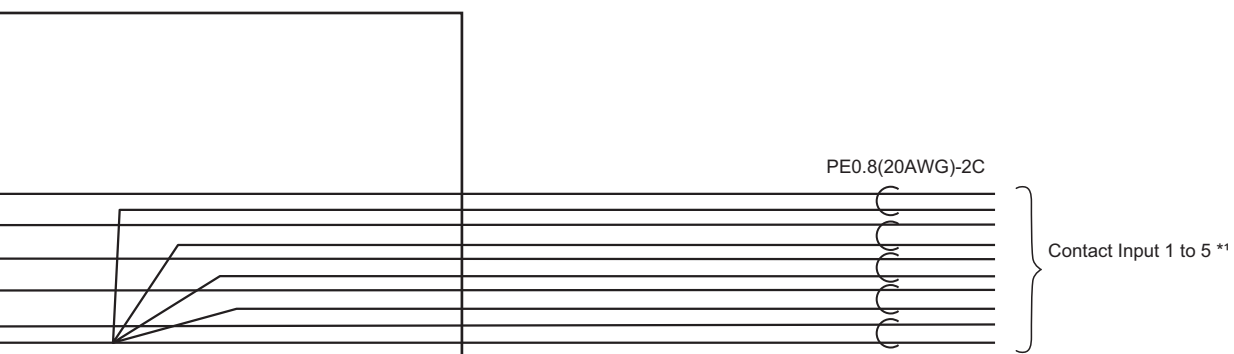
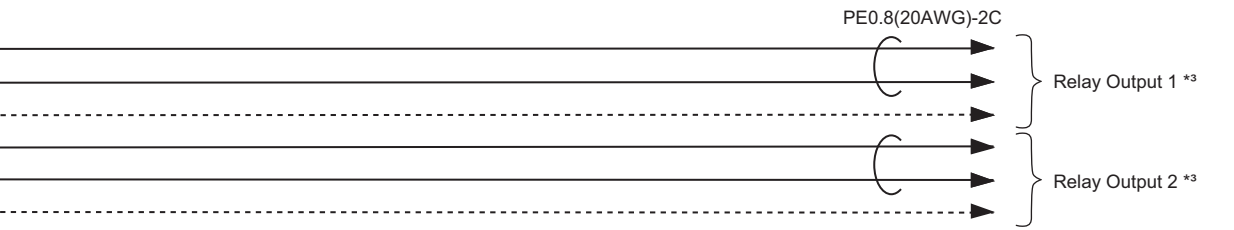

LAN PoE PSE      LAN PoE PD

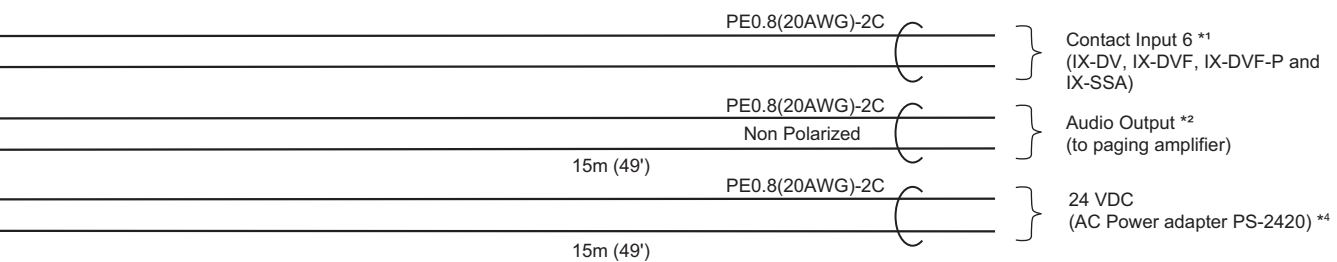
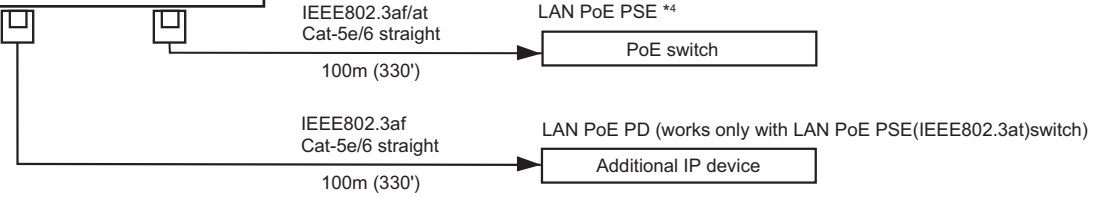

#### \*1 Contact Input Specifications

Input method	Programmable dry contact (N/O or N/C)
	Level detection method
Detection time	100 msec or more
Contact resistance	Make: 700 $\Omega$ or less Break: 3 k $\Omega$ or more
Terminal short-circuit current	20 mA or less
Voltage between terminals	5 VDC or less (between open terminals)

#### \*2 Audio Output Specifications

Output impedance	600 $\Omega$
Output audio level	300 mVrms (with 600 $\Omega$ termination)

#### \*3 Relay Output Specifications

Output method	Form C dry contact (N/O or N/C)
Contact rating	24 VAC, 1 A (resistive load) 24 VDC, 1 A (resistive load) Minimum overload (AC/DC): 100mV, 0.1mA

\*4 The intercom unit can be powered by using a PoE switch or Aiphone PS-2420 power supply. In the case "PoE PSE" output of the intercom unit is used to power other devices, IEEE802.3at compatible PoE switch must be used to power the intercom unit.

In the case both a PoE switch and Aiphone PS-2420 power supply are used in combination to power the intercom unit, PS-2420 can provide back-up power if the PoE power supply fails. this allows continuous recording function etc. to continue operating.



AIPHONE CO., LTD., NAGOYA, JAPAN

Issue Date: Dec.2019 FK2452 © P1219 BQ 62108