

☎ 0409 487 288

✉ graeme@mcgrathlocks.com.au



MLA210 Digital Lock



PO Box 173, WILSTON QLD 4051
ABN 84 617 577 876

www.mcgrathlocks.com.au

Description

This 5 in 1 digital door lock represents a classic easy entry option for your home. A stylish door lock with a Bluetooth App, pin code, RFID card and fingerprint, manual key to provide quick and convenient access.

Specifications

- Unlocking methods: app/fingerprint/code/RFID card/key
- Material: 304# stainless steel, ABS, Acrylic
- Colour: Silver, black
- Accept door thickness: 38-55mm
- Communication mode: Bluetooth
- Support system: Android 4.4 /IOS 7.0 above
- Battery life: 10,000 times normal open (12months)
- Power supply: 4pcs AAA Alkaline batteries
- Working Temperature: -20 ~ 50°C
- Working Humidity: 10% ~ 95%
- Available mortise: 28/85, 35/85, 45/85, 40/85, 50/85, 65/85, 70/85



Mortises dimensions

MLA210 Digital Lock

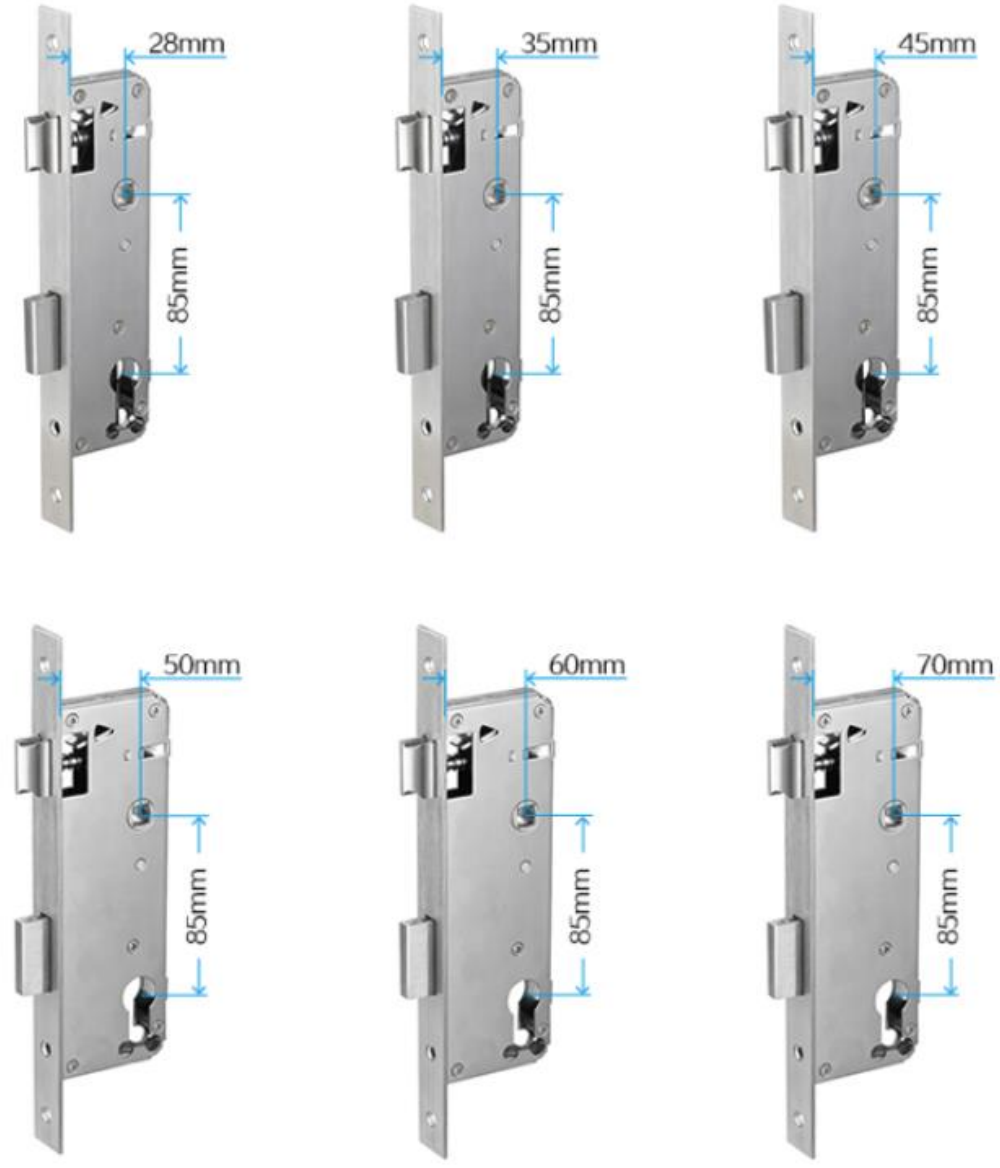

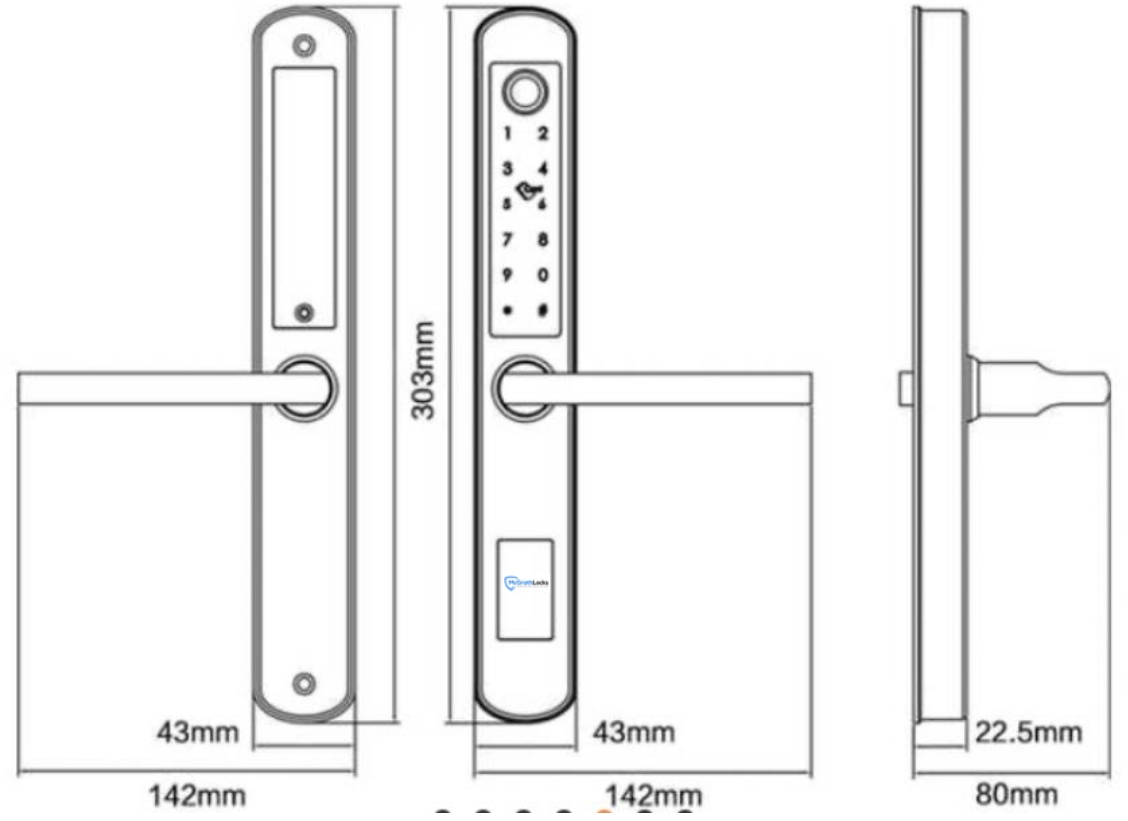
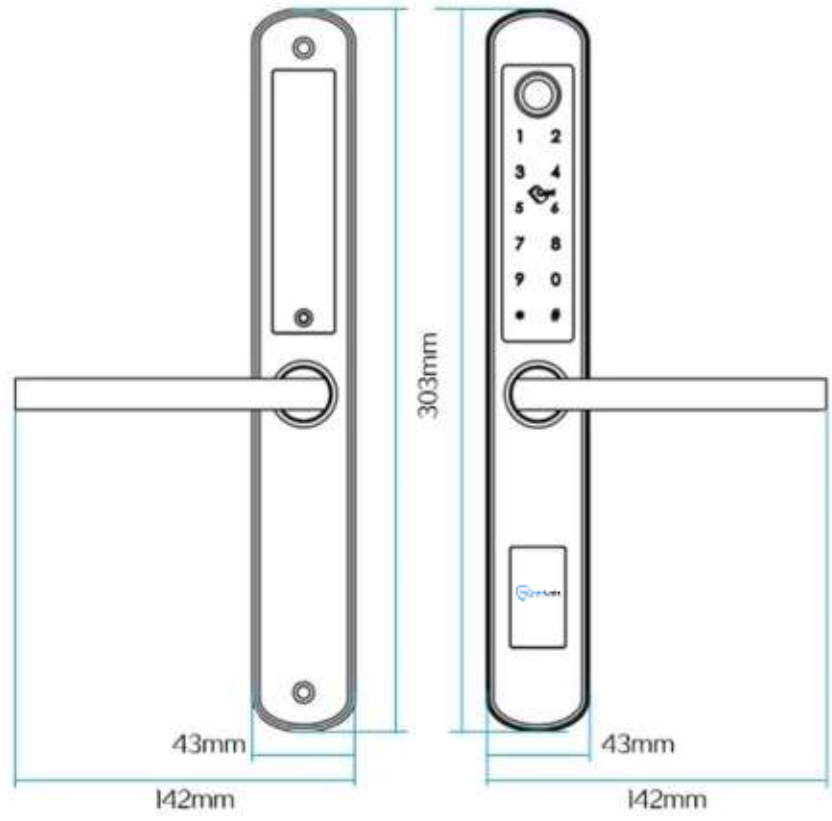

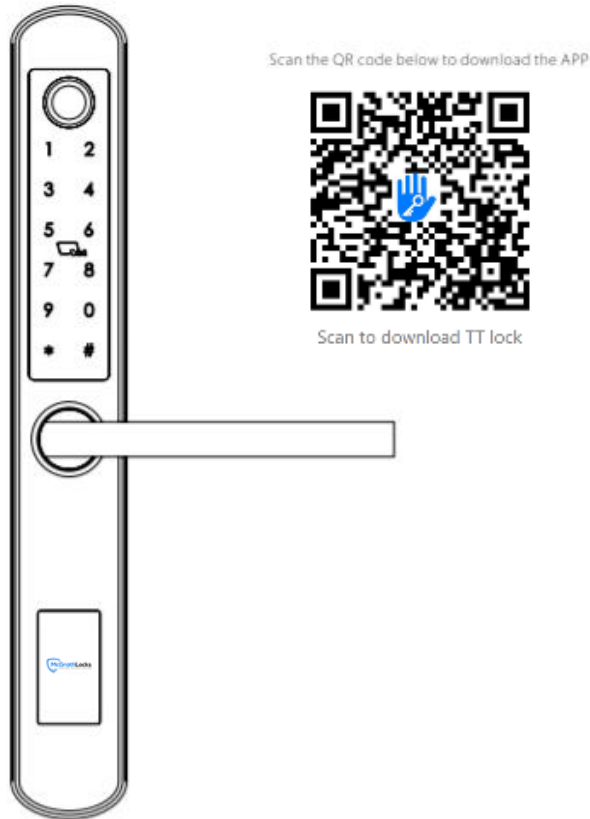

INFORMATION AND SAFTY WARNINGS :

1.1 Introduction:

This user manual will guide you through the functions and usages of our MLA210 Bluetooth enabled smart lock. It is important that you follow the instructions and regard all notes that appear throughout this manual. Consult this manual before you attempt to use the lock. If you have questions not answered by this manual or are in need of non-routine service, contact our customer service (Phone Number)

1.2 Safety Warnings:



When reading this manual, note these icons: notes with this icon MUST be read, understood and obeyed to prevent injury or damage.



General Usage:

- This lock shall only be used as described in this manual.
- Verify that all parts of the lock are account for. If any parts are missing, contact our customer service.
- In factory default status, the lock is on always open state after you install the lock (no power on). It means handle is free and lock can't be closed, you have to power on the lock with batteries or set admin and pair the lock with app and then the open mode will be changed to private mode automatically.
- Handle directions are reversible, please kindly follow chapter 4 (installation steps3) to change the direction. Should you have any problem, please contact our customer service.
- There is a protective film on the front touch panel, if there are some scratches on the film, don't be scared. The protective film can be removed if you need.
- Use only four AAA batteries. Do not mix old and new batteries or batteries from different brands. Never insert objects into the lock other than batteries as described in this manual.
- Verify all surfaces are flat and level before beginning installation, installation on doors or surface with any types of deformity such as gaps or warping may cause the lock to malfunction or fail to operate entirely.
- Never apply any cleaner directly to any part of the lock. Only use clean water and mild cleaner on a soft non-abrasive cloth when cleaning.
- Potential shock warning: do not allow water or liquids to get into lock's electric parts.
- The lock must be used with TT lock app. The lock will function without the app but full functionality may only be achieved when the app is used.



IC Card



Passcode



Key



APP



Fingerprint



Wristband

PREPARING TO INSTALL :

1.1 Line Drawing

Draw a horizontal centre line inside and outside the door at 1 meter from the ground. Fold the hole template, make the handle centre line align at the door horizontal centre line, then draw out the hole lines at front and side.

1.2 Determining Lever Handing:

The hand of the door is determined from the secure side of the door. The term “secure” means the side from which you initially unlock and enter from outside.



The hand of a door is determined from the secure side of the door. The term "secure" means the side from which you initially unlock and enter.

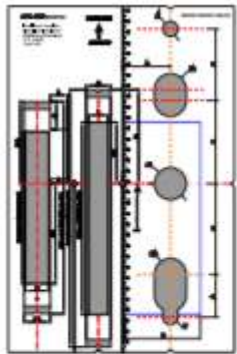

Template

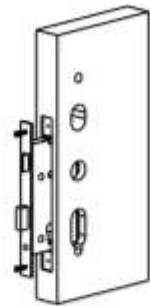

Trepanning



Screwdriver

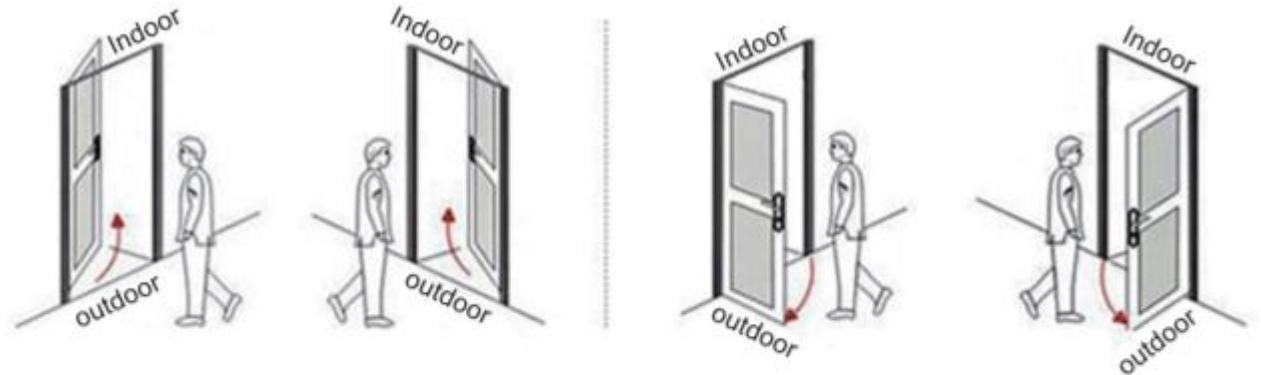

Left Push

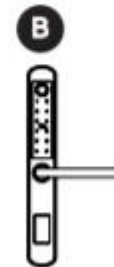

Right Push

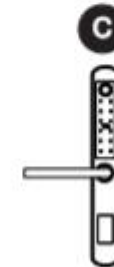

Left Pull



Right Pull

SYSTEM SPECIFICATION :

Connectivity	Bluetooth 4.0, Wi-Fi (Wi-Fi Bridge required)
Identification Mode	TTLock App, Fingerprint, Card (Mifare 13.56 MHz), Code and Bluetooth
User Capacity	120
Identification Time	Instant recognition under 0.3 seconds
Code	User-defined 4-8 digit
Keypad Backlight	Yes
Temporary Code or Ekey	Yes
Compatible Smartphone	iOS7.0 or above, Android 4.4 or above
Remote Access	Yes, Wi-Fi Gateway
Mechanical Key Override	Yes
Micro-USB Backup Power Interface	Yes
Working Voltage	6 V (4 X Alkaline AAA Batteries)
Working Temperature	External Assembly: -4 °F ~ 149 °F (-20 °C ~ 65 °C) Internal Assembly: 14 °F ~ 131 °F (-10 °C ~ 55 °C)
Battery Life	Up to 12 months (10,000 times access)
Compatible Smart Home Eco-system	Alexa and Google Assistant (Wi-Fi Gateway is required)
Hardware Type	Lever
Door Thickness	38 - 55 mm
Door Handing	Reversible (Left and Right)

Case Material	304# stainless steel, ABS, Acrylic
IP Rating	IP65
Finish	Satin Nickel or Black
Dimensions	Exterior Assembly - 330 x 43 x 22.5 mm Interior Assembly - 330 x 43 x 22.5 mm
Weight	3 kg
Warranty	12 Months
Available Mortise	35/85,45/85,50/85,60/85,70/85 European mortise
Tubular Latch	No
Working Humidity	10%~95%
Factory Passcode	123456, after setting, factory passcode will be invalid
WiFi Gateway	Available(Optional)
Unlock time	1-1.5 seconds
Dynamic current	<200mA
Static current	45uA



EXPLODED VIEW :

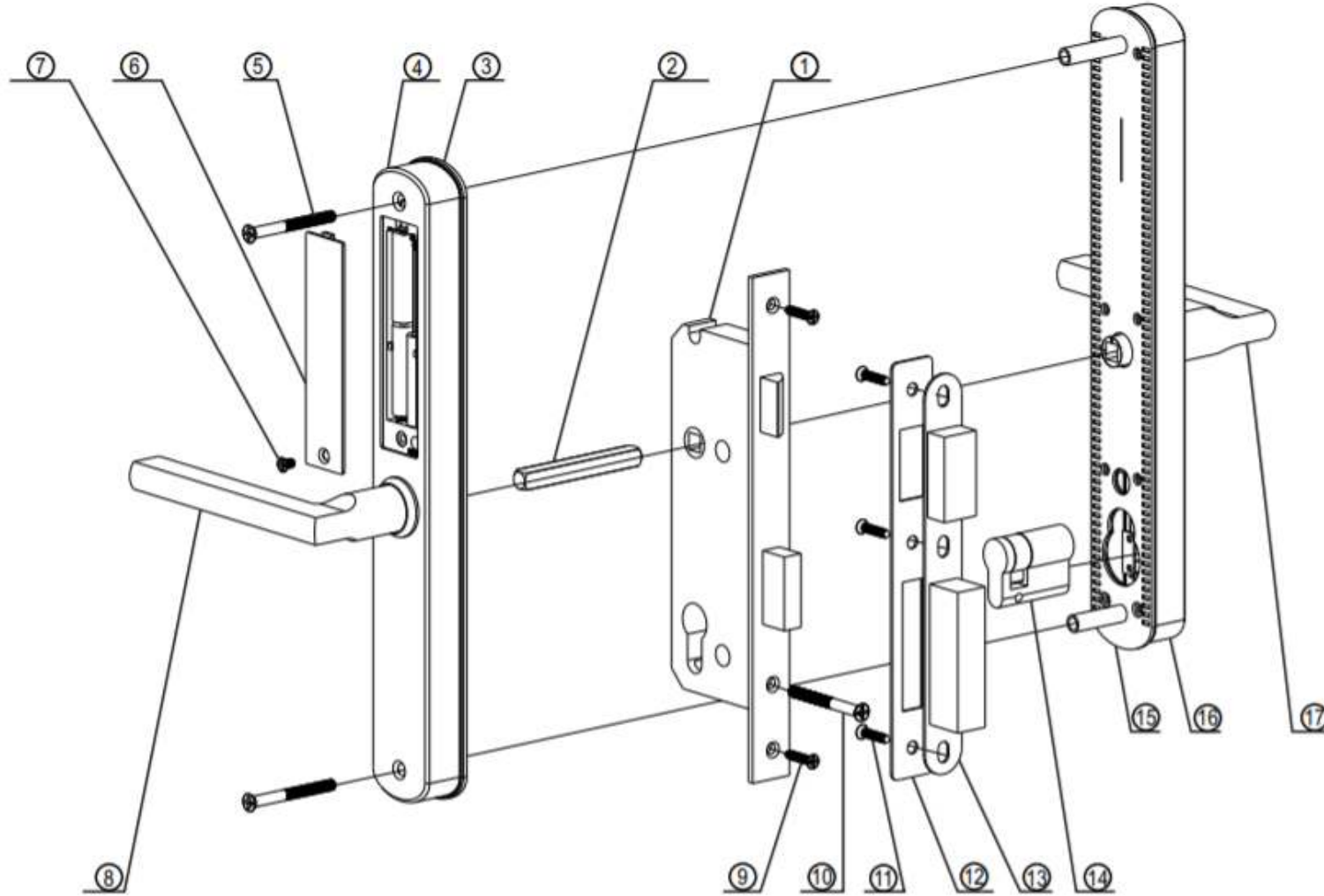

No.	Name	Quantity	No.	Name	Quantity
1	Mortise	1	10	Cylinder Screw	1
2	Spindle	1	11	Strike Screw	3
3	Rubber Gasket	1	12	Strike	1
4	Back Panel	1	13	Strike Box	1
5	Assemble Screw	2	14	Cylinder	1
6	Battery Box Cover	1	15	Front Gasket	1
7	Battery Cover	1	16	Front Panel	1
8	Back Handle	1	17	Front Handle	1
9	Faceplate Screw	2			

Front Panel

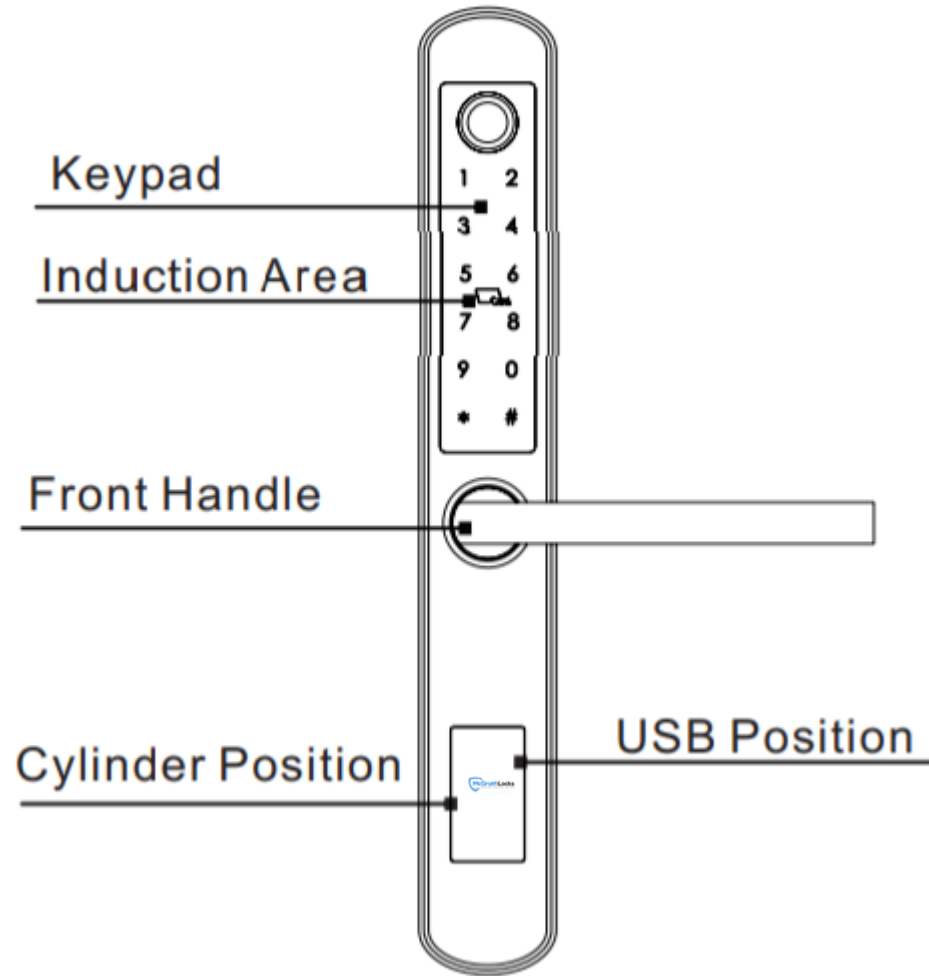

Back Panel

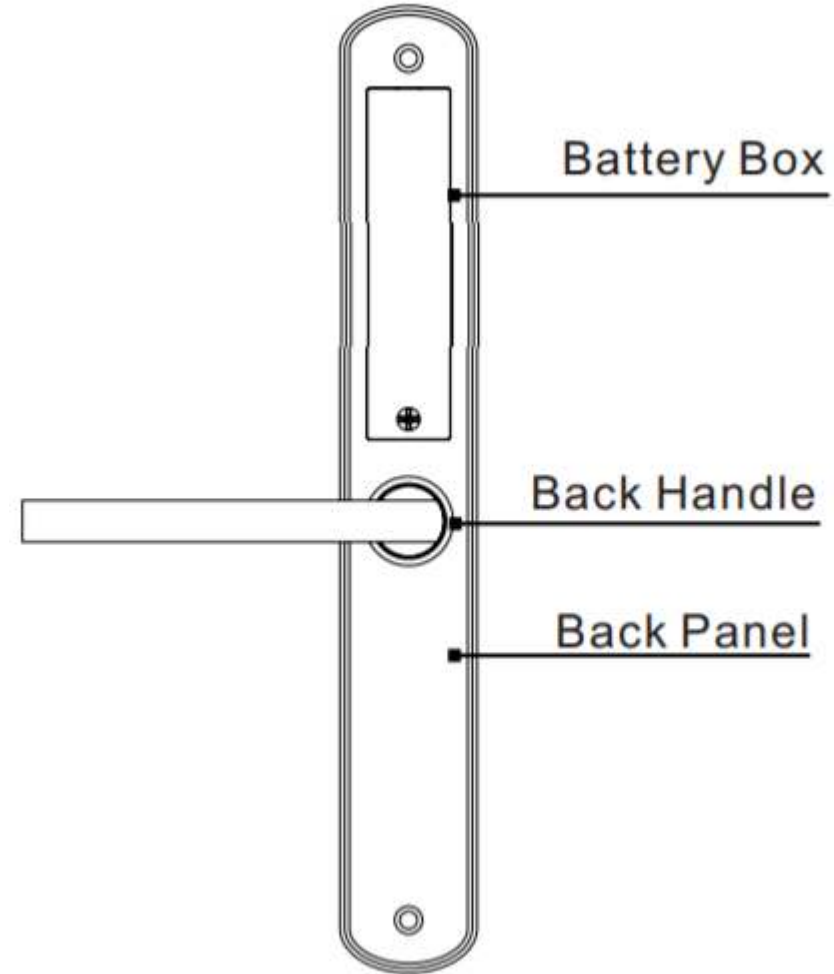

RESET TO FACTORY STATE :

▲ Attention

Long press the reset button for 2 seconds until you can hear 2 beeps to set back into factory state. Default passcode is :123456. Under the factory state, the lock is always open state, only when you power The lock, the motor will reset and the handle will be in free state.

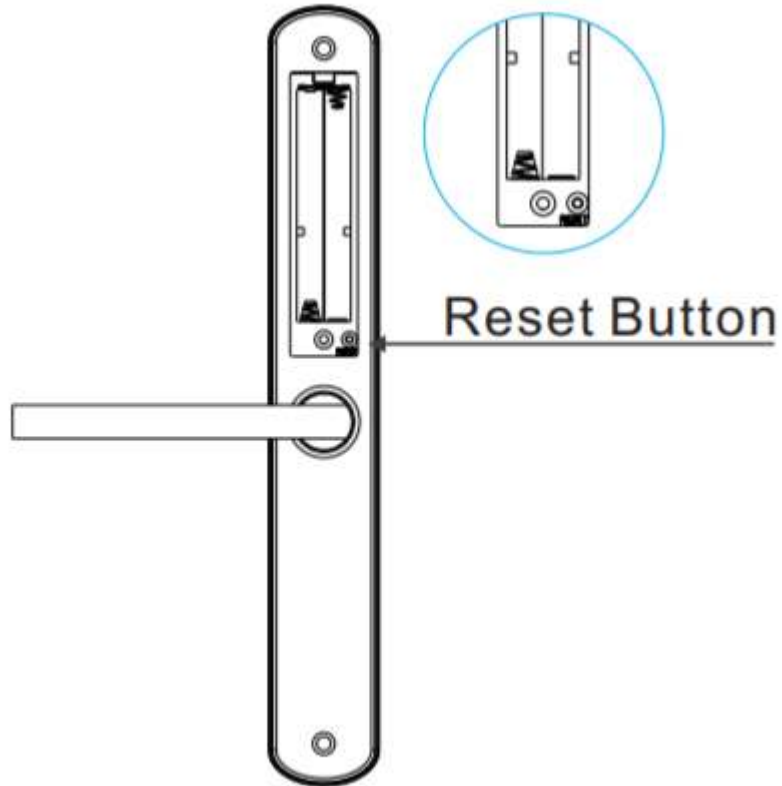

MLA210 LOCK ACCESSORIES :

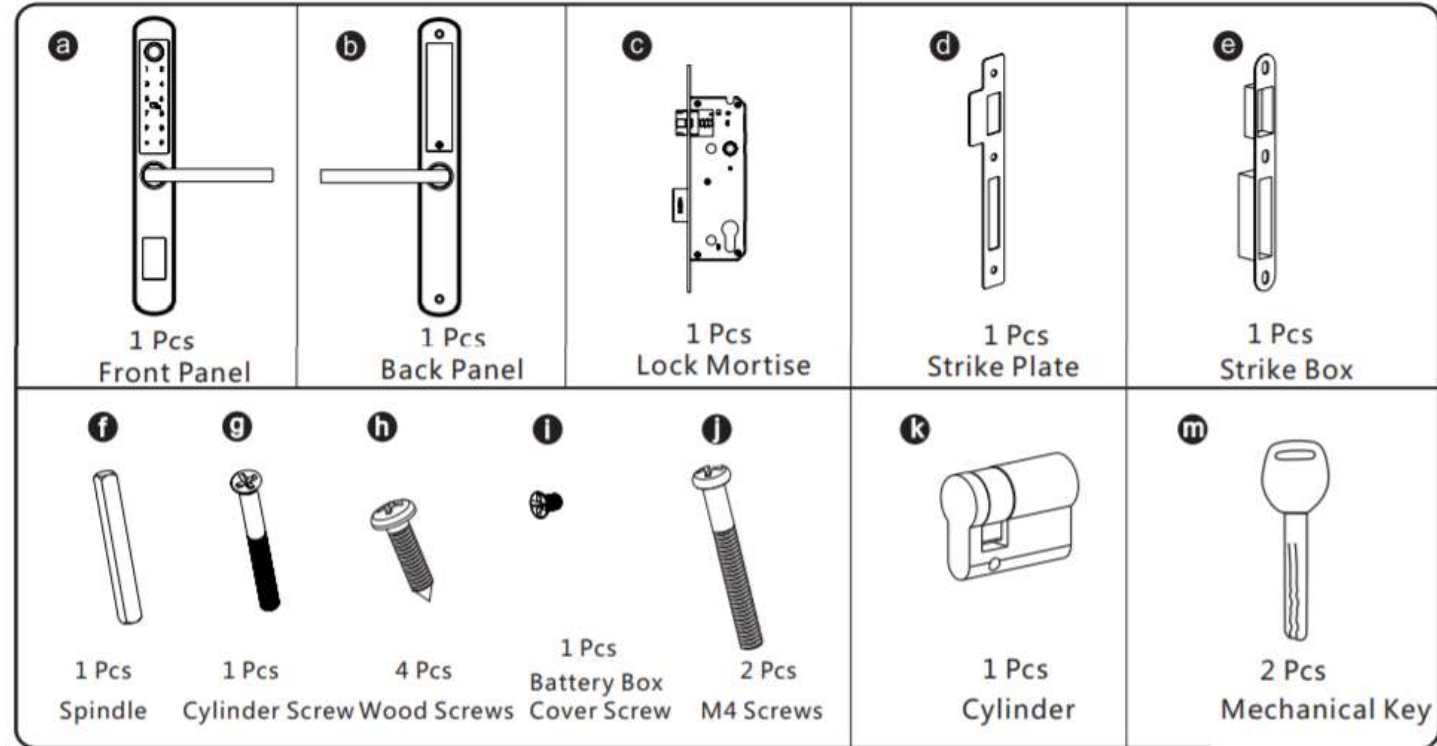

INSTALLATION STEPS :

1. Assemble the Mortise

Assemble the mortise (C) into the slot which is drilled according to the template.

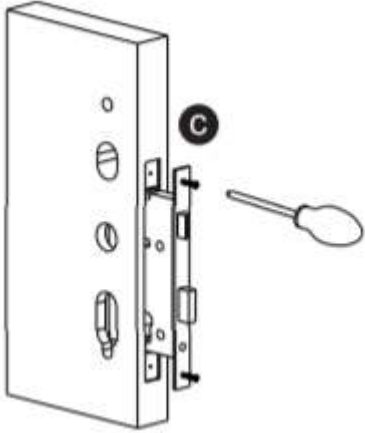

2. Assemble the Cylinder

Fix the cylinder (K) with the long screw through the hole on the faceplate.

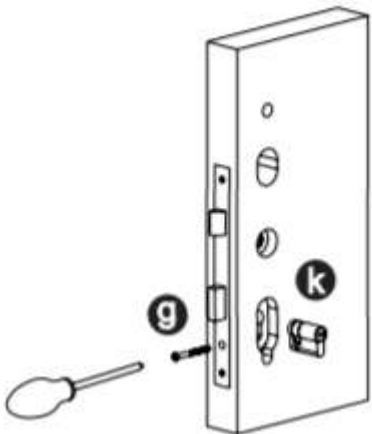

3. Assemble the Front Panel

Tight the front panel on the door(outside).

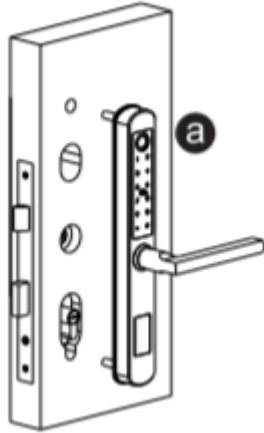

4. Assemble the back panel

Tight the back panel with front panel with the two long screws (F).

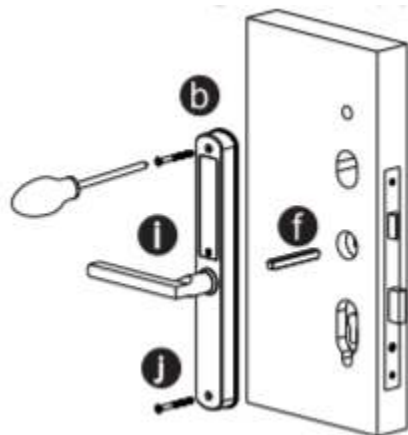

5. Assemble the Strike and Box

Put the strike box into the slot and fix the strike with the screws.

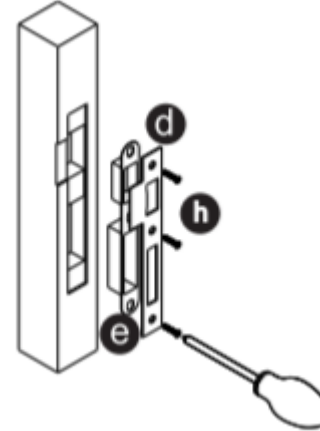

6. Test with the mechanical key

Test to unlock the door with the mechanical key and adjust the position if it is not smooth.

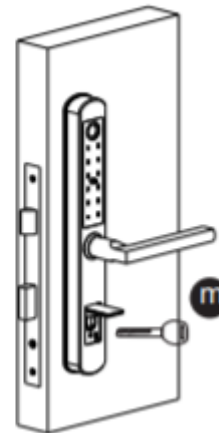

7. Test the Lock

Put 4pcs AAA alkaline batteries into the battery box and test with factory passcode or APP .

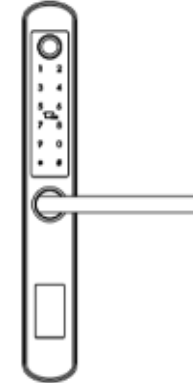

8. Adjust the Lock Panel

After test, please adjust the position of the lock panel or the screws if it is too tight.

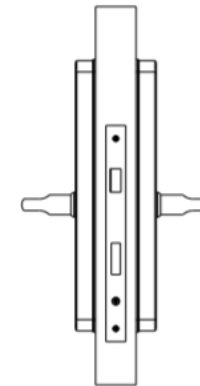

Change Handle :

1. Adjust the Front Handle Direction

- 1.1 Use the allen key to take off the screw from the handle head.
- 1.2 Take off the handle.
- 1.3 Rotate the handle 180 degree and fix the direction that you need.
- 1.4 Tighten the screw with the allen key.
- 1.5 Adjust the clutch direction as the sign on the right.

2. Adjust the Back Handle Direction

- 2.1 Use the allen key to take off the screw from the handle head.
- 2.2 Take off the handle.
- 2.3 Rotate the handle 180 degree and fix the direction that you need.
- 2.4 Tighten the screw with the allen key.
- 2.5 Adjust the handle if it is too tight

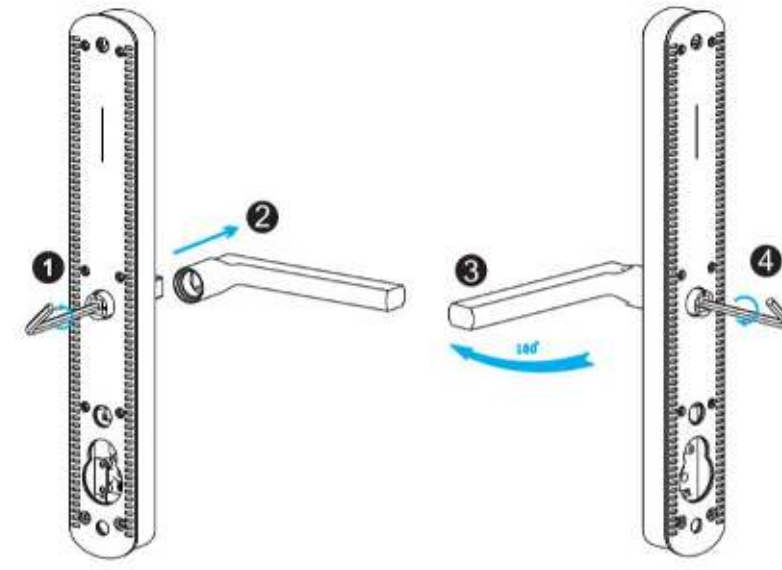
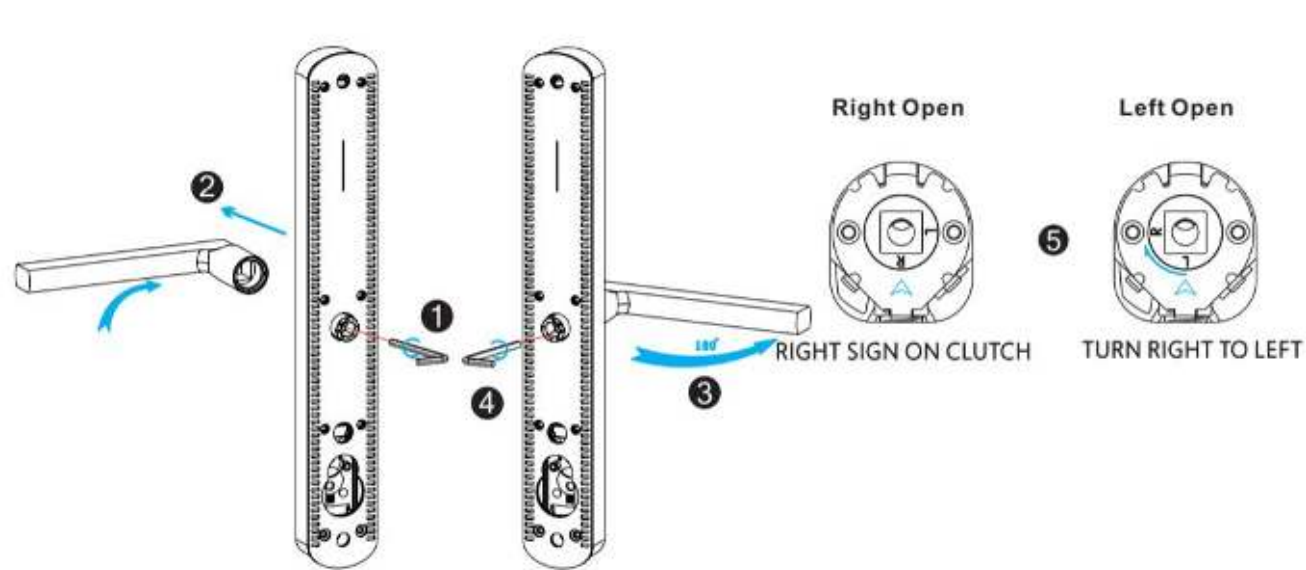

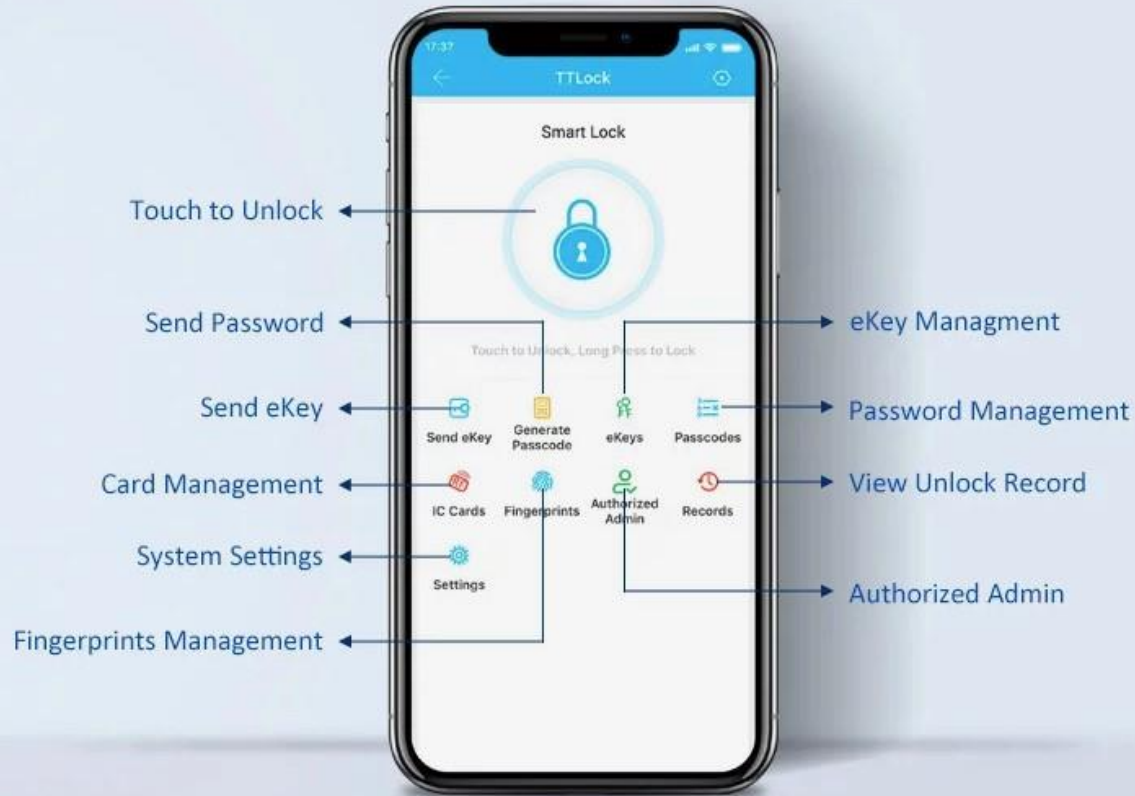

Operations for Bluetooth Digital Lock



Contacts

Address

PO Box 173
Wilston QLD 4051

Phone – Maintenance & Warranty Enquiries
0456 960 050

Phone – Sales
0409 487 288

Email – Enquiries
info@mcgrathlocks.com.au

