

# PASSIVE INFRARED SENSOR

CE  PA-4810 (WIDE ANGLE)

CE  PA-4820 (LONG RANGE)

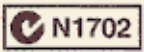
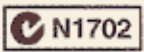

OPTIONAL : ATTACHMENT BCW-401

## WALL MOUNT HIGH QUALITY PASSIVE INFRARED SENSOR

### FEATURES

#### ORIGINAL QUAD ELEMENT + NEW SIGNAL PROCESSING (FUZZY LOGIC)

PULNiX original quad pyroelectric sensor improves sensitivity. This newly developed original pyroelectric sensor coupled with new Fuzzy Logic provides high catchability.

#### MIRROR OPTICS AND EASY AIMING SYSTEM

Precise mirror optics and new quad element assure high sensitivity and high reliability. As mirror and head unit move together, area adjustment does not reduce blur sensitivity. PULNiX original view finder assures precise and quick adjustment.

#### TROUBLE ALARM

Unit monitors the following functions. When a trouble condition is detected, the alarm LED lights and trouble alarm is initiated.

**Unit trouble** ... A trouble alarm triggers when inner circuitry/wiring is damaged/broken.

**Low voltage** ... A trouble alarm triggers when sensor detects a drop in supply voltage.

**Failure to replace**... A trouble alarm triggers when head unit is not replaced after adjustment is completed.

#### FINE MOTION DETECTION

Unit can be adjusted from quad element sensing to two twin element by built-in switch for situations where close range detection is desirable.

\*Alarm LED disable (ON / OFF)

\*Alarm contact changeover (N.C. / N.O.)

\*Sensitivity adjustment (50%, 80%, 100%, 120%)





#### ALARM MEMORY

Units contain special circuitry to indicate an alarm has been activated during armed period. Especially useful when more than one unit is used per zone.

#### REMOTE LED CONTROL

Allows the LED to be enabled/disabled via the control panel.

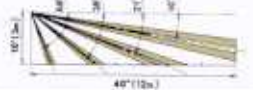
## ■ COVERAGE

Model	PA-4810	PA-4820
	WIDE ANGLE	LONG RANGE
TOP VIEW		
SIDE VIEW		

## ■ TERMINAL ARRANGEMENT

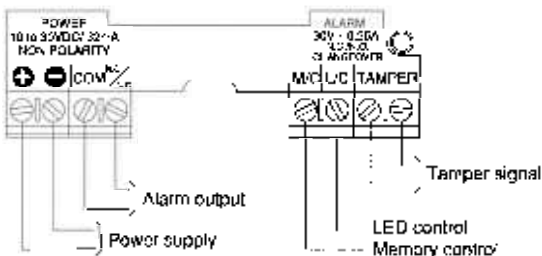

## ■ EXTERNAL DIMENSIONS

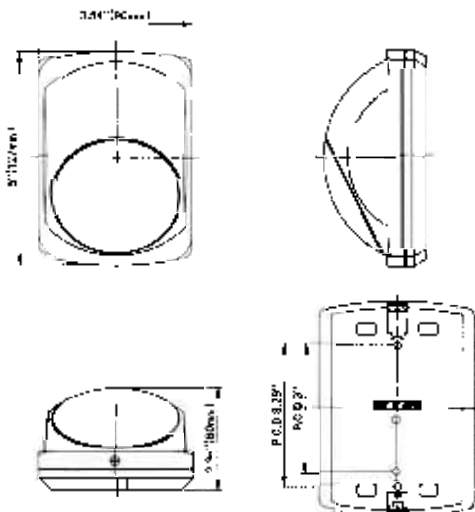

## ■ SPECIFICATIONS The specifications are subject to change without notice.

Model	PA-4810	PA-4820
Detection	Passive infrared (Quad • Fuzzy logic)	
Coverage	Wide angle 12m Max (40')	Long range 25m Max (83')
Number of sensitive zone	18 pairs (72)	6 pairs (24)
Mounting positions	Indoor wall / pillar	
Supply voltage	10 to 30 V DC (non-polarity)	
Power consumption	32mA Max	
Alarm output	Dry contact relay ( N.C. / N.O. changeover ) Reset : approx. 2 sec 30V (AC/DC) 0.25A Max ( resistive load ) ( protective resistance built-in 3.3Ω )	
Tamper signal	Dry contact (N.C) Open when cover is detached 30V (AC/DC) 0.1A Max ( resistive load )	
Fine motion detection	36 pairs	12 pairs
Alarm LED	Red LED Warm up : flickering ( every 0.5 sec.) Alarm : solid ( approx. 2 sec. ) Memory : continuous solid Trouble alarm : continuous solid ( LED disable)	
Memory control	Controls memory indication/ reset with terminal M/C	
LED control	Controls alarm LED indication with terminal L/C	
Trouble alarm	Unit trouble : monitors damage on inner circuitry / wiring ( Operate : initiate trouble alarm ) Low power voltage : monitors drop in power voltage ( Operate : initiate trouble alarm ) Failure to replace : monitors failure to replace head unit ( Operate : initiate trouble alarm )	
Ambient temp. range	-10°C to +50°C ( +14°F to +122°F ) without condensation	
Wiring	Terminals	
Area adjustment	Vertically : 20"	Horizontally : ±5"
Weight	5.8 oz. (165g)	
Accessory	Fixing screw : 4 × 30 2pcs.	

The passive infrared sensor is designed to detect infrared energy variations caused by the presence of a human body. Therefore, note that similar variations in conditions in protected area, due to other reasons, may cause the sensor to create an alarm as it is unable to distinguish between sources

**Please note** : This sensor is designed to detect intrusion and to initiate an alarm ; it is not a burglary - preventing device.

PULNiX is not responsible for damage, injury or losses caused by accident, theft, Acts of God ( including inductive surge by lightning), abuse, misuse, abnormal usage, faulty installation or improper maintenance.