

**TAKEX**

# PHOTOELECTRIC BEAM SENSOR

PB-10NS(E)	:SINGLE BEAM 33ft. (10m)	(N.C./N.O. Selectable)
PB-4RNS(E)	:SINGLE BEAM REFLECTIVE 13ft. (4m)	(N.C./N.O. Selectable)
PB-10TNS(E)	:TWIN BEAM 33ft. (10m)	(N.C./N.O. Selectable)
PB-4RTNS(E)	:TWIN BEAM REFLECTIVE 13ft. (4m)	(N.C./N.O. Selectable)

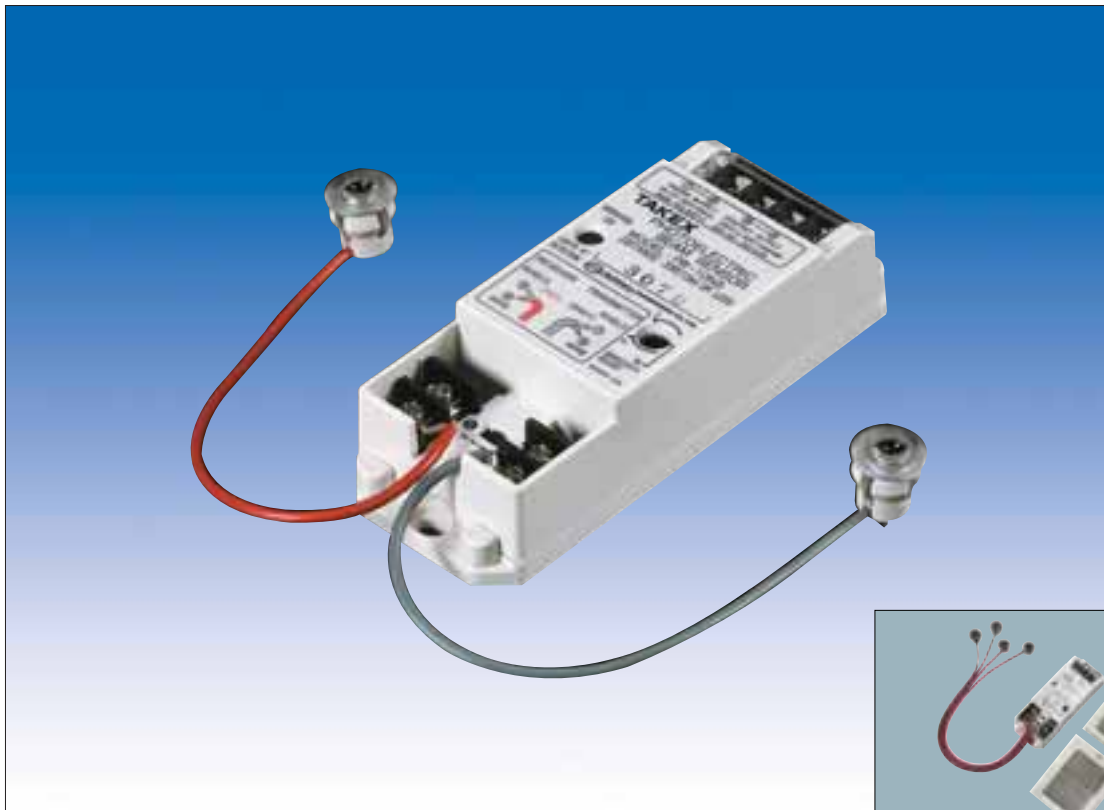

PB-10NS(E)



PB-4RTNS(E)

## MINIATURIZED PHOTOELECTRIC BEAM SENSOR DOESN'T USE MUCH SPACE FOR INSTALLATION!

### DESCRIPTION

MINIATURIZED PHOTOELECTRIC BEAM SENSOR is suitable for use inconspicuously in a wide range of applications. (for CD/ATM machine, motor-driven shutter, window or alley.)

For CD/ATM machine

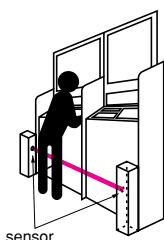

For window

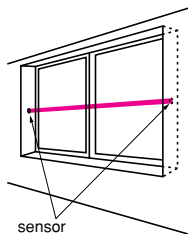

### EASY INSTALLATION

For sensor head, make a preliminary hole and push it only to be installed.

### BUILT-IN SENSITIVITY CONTROL

Adjustable to the optimal sensitivity as the installation site demands.

### SENSOR CORD CAN BE CUT TO LENGTH

Both of transmitter cord and receiver cord can be cut as the installation site requires.

No need to bundle the extra cord.

### 4 MODELS AVAILABLE

PB-10NS(E) Single beam TR/RE type 33ft. (10m)

PB-4RNS(E) Single beam reflective type 13ft. (4m)

PB-10TNS(E) Twin beam TR/RE type 33ft. (10m)

PB-4RTNS(E) Twin beam reflective type 13ft. (4m)

### MINIATURIZED CONTROL BOX

Miniaturized control box [W:1.77" (45mm) × H:4.72" (120mm) × D:1.14" (29mm)] does not use much space for installation.

# PHOTOELECTRIC BEAM SENSOR

## COVERAGE

### ●PB-10NS(E)/PB-10TNS(E)

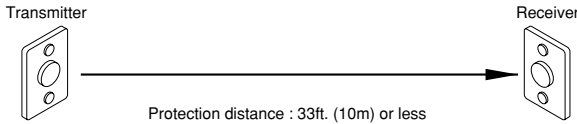

●Sensitivity adjustment  
(Adjust the sensitivity adjustment control depending on the protection distance.)

Protection distance	Sensitivity adjustment
Less than 10' (3m)	M
More than 10' (3m)	H

### ●PB-4RNS(E)/PB-4RTNS(E)

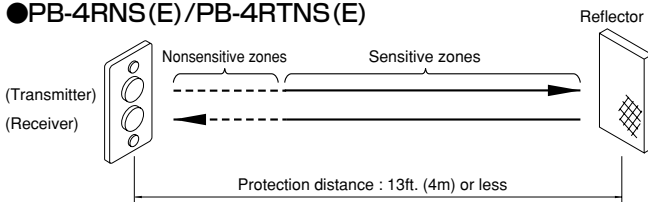

(Note) Nonsensitive zones depend upon the sensitivity volume.

Sensitivity volume	Nonsensitivity zone
L	Within 5.9" (15cm)
M	Within 11.8" (30cm)

## TERMINAL ARRANGEMENT

### ●PB-10NS(E)/PB-4RNS(E)

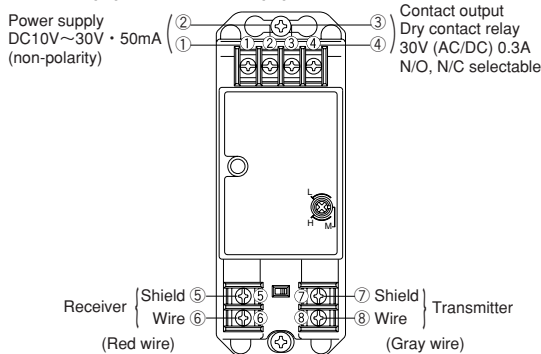

### ●PB-10TNS(E)/PB-4RTNS(E)

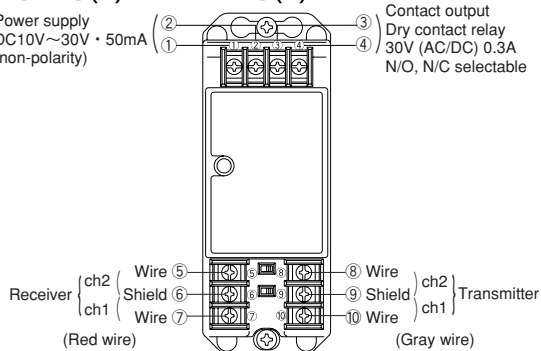

## EXTERNAL DIMENSIONS unit:inch (mm)

### ●Control box <All models common>

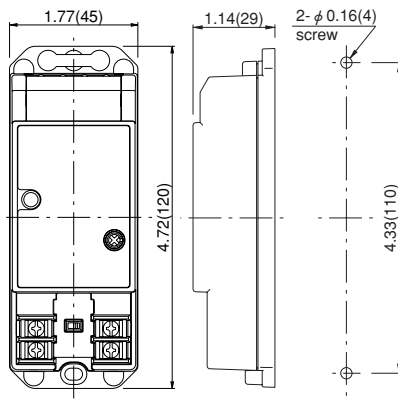

### ●Reflector <PB-4RNS(E)/PB-4RTNS(E)>

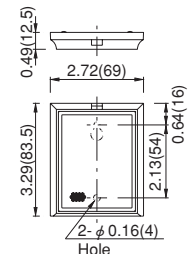

### ●Flush mounting plate

<PB-10NS(E)/PB-10TNS(E)> <PB-4RNS(E)/PB-4RTNS(E)>

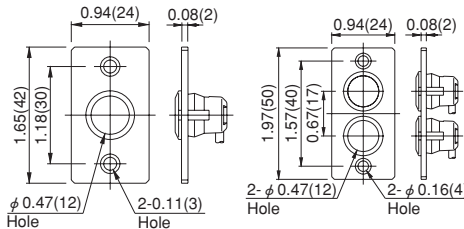

### ●Sensor (Transmitter and Receiver)

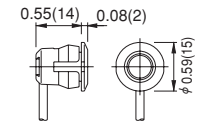

## SPECIFICATIONS

Model	PB-10NS(E)	PB-4RNS(E)	PB-10TNS(E)	PB-4RTNS(E)
Detection system	Near infrared TR/RE type	Near infrared reflective type	Near infrared TR/RE type	Near infrared reflective type
Protection distance	33ft. (10m) or less	13ft. (4m) or less	33ft. (10m) or less	13ft. (4m) or less
Supply voltage	DC10V to DC30V (Non-polarity)			
Current consumption	45mA or less		55mA or less	
Alarm output	Dry contact relay : 30V (AC/DC) 0.3A N/O, N/C selectable Contact action : Interruption time+Delay time (approx. 1 sec.)			
Response time	Detect 100msec. or more of beam interruption			
Operation LED	Lights Red during detection (beam is interrupted)			
Ambient temperature range	-13°F to +131°F (-25°C to +55°C) (without condensation or frozen)			
Appearance	Sensor : PC resin (clear) Control box : ABS resin (white)			
Weight	Sensor : 4.2oz (120g)×2 Control box : 3.3oz (95g)		Sensor : 2.1oz (60g)×2 Control box : 3.3oz (95g)	

The specifications are subject to change without notice.

**Please note :** This sensor is designed to detect intrusion and to initiate an alarm; it is not a burglary-preventing device. TAKEX is not responsible for damage, injury or losses caused by accident, theft, Acts of God (including inductive surge by lightning), abuse, misuse, abnormal usage, faulty installation or improper maintenance.

LEAF07-04R25-3

# TAKEX

### In Japan

**Takenaka Engineering Co., Ltd.**  
83-1, Gojo-sotokan,  
Higashino, Yamashina-ku,  
Kyoto 607-8156, Japan  
Tel : 81-75-501-6651  
Fax: 81-75-593-3816  
<http://www.takex-eng.co.jp/>

### In the U.S.

**Takex America Inc.**  
230 E. Caribbean Drive  
Sunnyvale,  
CA 94086, U.S.A.  
Tel : 408-747-0100  
Fax: 408-734-1100  
<http://www.takex.com>

### In Australia

**Takex America Inc.**  
Unit 16/35 Garden Road,  
Clayton, 3168 Victoria,  
Australia  
Tel : 03-9546-0533  
Fax: 03-9547-9450

### Takex America Inc.

Brisbane office : 1/50 Logan  
Road, Woolloongabba  
Queensland  
4102, Australia  
Tel : 07-3891-3344  
Fax: 07-3891-3355

### In the U.K.

**Takex Europe Ltd.**  
Takex House, Aviary Court,  
Wade Road, Basingstoke,  
Hampshire. RG24 8PE, U.K.  
Tel : (+44)01256-475555  
Fax: (+44)01256-466268  
<http://www.takexurope.com>