

# LOOP-WIRED HANDSET INTERCOM

(YAZ PHONE TYPE INTERCOM)

Models: **YAZ-90-3W**

## INSTALLATION & OPERATION MANUAL

This Manual and the Markings on the product contain various symbols in order that the product can be used safely and properly, and that the installer and user are protected from injury and property damage. The following precautions must be thoroughly read and understood before proceeding.

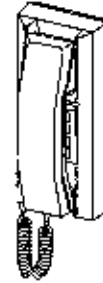







### PRECAUTIONS ON INSTALLATION

 **WARNING** *Negligence could result in death or serious injury to people.*





 **CAUTION** *Negligence could result in injury to people or damage to property.*



The following precautions are also applied to YAW-RB adaptors.

#### **WARNING**

1. Do not dismantle or alter the unit. Fire or electric shock could result. 
2. Do not connect any power source other than specified to terminals +, - nor install two power supplies in parallel to single input. Fire or electric shock could result. 
3. Keep the unit away from water or any other liquid. Fire or electric shock could result. 
4. Do not put any metal into the unit through the openings. Fire or electric shock or unit trouble could result. 
5. Do not plug or unplug with wet hands.  Electric shock could result.
6. Do not use DC power supply with a voltage other than specified. Fire or electric shock could result. 

#### **CAUTION**

1. Before turning on power, make sure wires are not crossed or shorted. Fire or electric shock could result. 
2. When mounting the unit on wall, install the unit in a convenient location, but not where it could be jarred or bumped. Injury could result. 
3. Do not install or make any wire terminations while power supply is plugged in. It can cause electrical shock or damage to the unit. 
4. Do not manually hold down hook switch while testing and verifying call tone volume. The call tone is very loud in earpiece, and could cause hearing damage. 

5. Do not install the unit in any of the following locations. 
  - Fire, electric shock or unit trouble could result.
  - Places under direct sunlight, or near heating equipment that varies in temperature.
  - Places subject to dust, oil, chemicals.
  - Places subject to moisture and humidity extremes, such as bathroom, cellar, greenhouse, etc. 
  - Places where the temperature is quite low, such as inside a refrigerated area or in front of air-conditioner.
6. On products with ground terminals, connect to an earth ground. Fire or malfunction could result. 

#### **GENERAL PRECAUTIONS**

1. The unit is for domestic use only. Do not use outdoors.
2. When wall mounted, the unit may become dusty. Clean with a soft cloth.
3. In areas where broadcasting station antennas are close by, the intercom system may be affected by radio frequency interference.
4. The unit case may become a little warm with use, but this is not a unit malfunction.
5. If a cellular phone is used close by, the unit may malfunction.
6. Keep the unit more than 1m away from Radio or TV set.
7. If the intercom station is operated near OA equipment, Radio or TV, they interactively influence by radio frequency interference. Carefully select locations for both installation and operation.

#### Examples of Symbols;

 **GENERAL PRECAUTIONS**

The  mark indicates caution statement (incl. danger and warning), which is specifically shown inside.

 **GENERAL PROHIBITIONS**

The  mark indicates contents which prohibit a specific action shown inside or attached.

 **GENERAL INSTRUCTIONS**

The  mark indicates contents which demands a specific action shown inside or attached.

 **DISMANTLE PROHIBITIONS**

 **MOISTURE PROHIBITIONS**

# 1 SYSTEM OUTLINE & COMPONENTS

YAZ-90-3W is a microprocessor based phone-style intercom, loop-wired with max. 4 twisted pair wires throughout system for up to 90 Stations. Each Station can dial 2-digit numbers and communicate with any other, initiate page to a single zone on one to max. 3 talk channels.

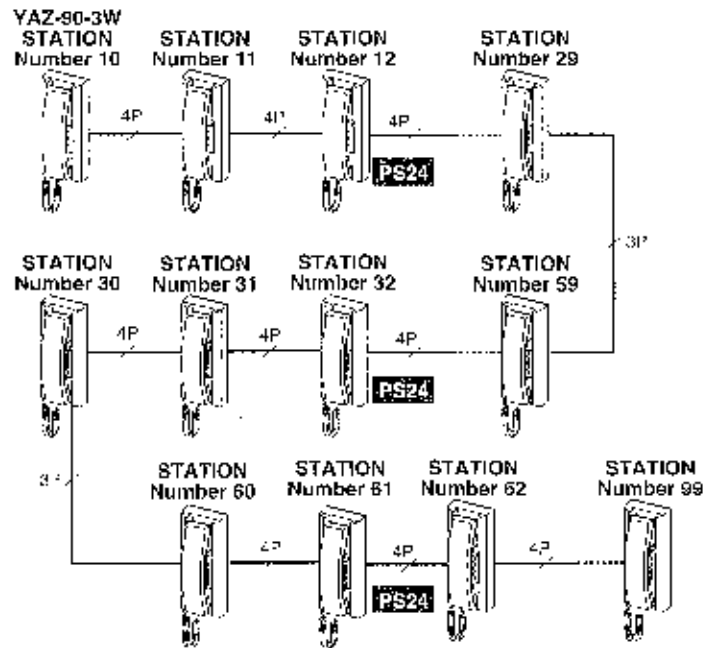

## SYSTEM COMPONENTS

**Station unit**  
YAZ-90-3W Phone-style intercom (max. 90)

**Power supply**(24V DC, 2A) **PS24**  
PS-2420S 100 - 240V AC, 50/60Hz.  
PS-2420DIN 230V AC, 50Hz.  
PS-2420UL 100-240V AC, 50/60Hz.

**Paging adaptors**  
YAW-RB Single zone paging adaptor

\* Each zone requires a paging adaptor, PA amplifier and a desired number of speakers.

When talkback is included; Release PAGE button and listen.

# 2 NAMES & FEATURES

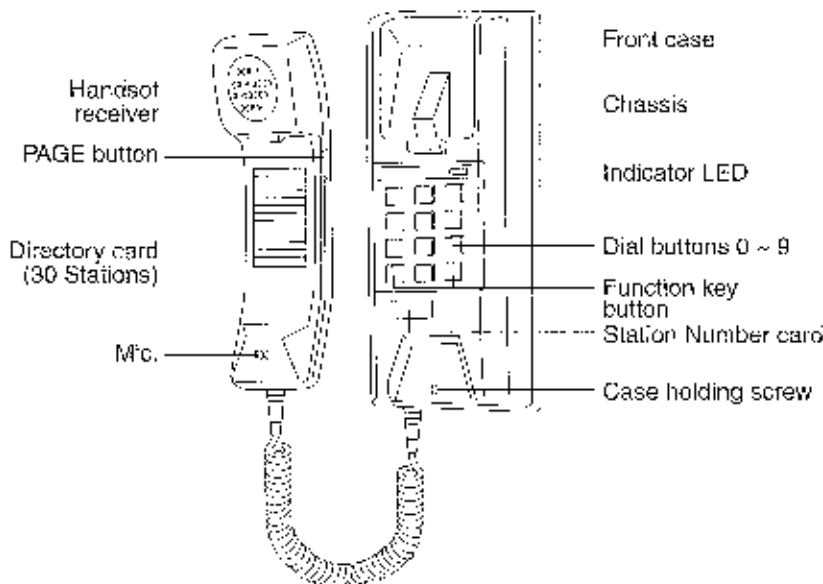

## SYSTEM FEATURES

- Max. 90 Stations
- Loop-wired throughout system with 2 to 4-twisted pairs
- 3 talk channels
- Communication privacy
- Incorrect wiring causing malfunction on a channel, does not affect the rest of channels
- Easy Station Number setting with dip switch combinations
- Built-in communication functions as standard, such as call transfer, camp-on busy, secretary transfer

# 3 INSTALLATION

## ACTUAL TERMINAL LOCATION

The connecting terminals are located inside the chassis. Two identical rows of the terminals are provided, one is to connect incoming wires and the other is to connect outgoing wires.

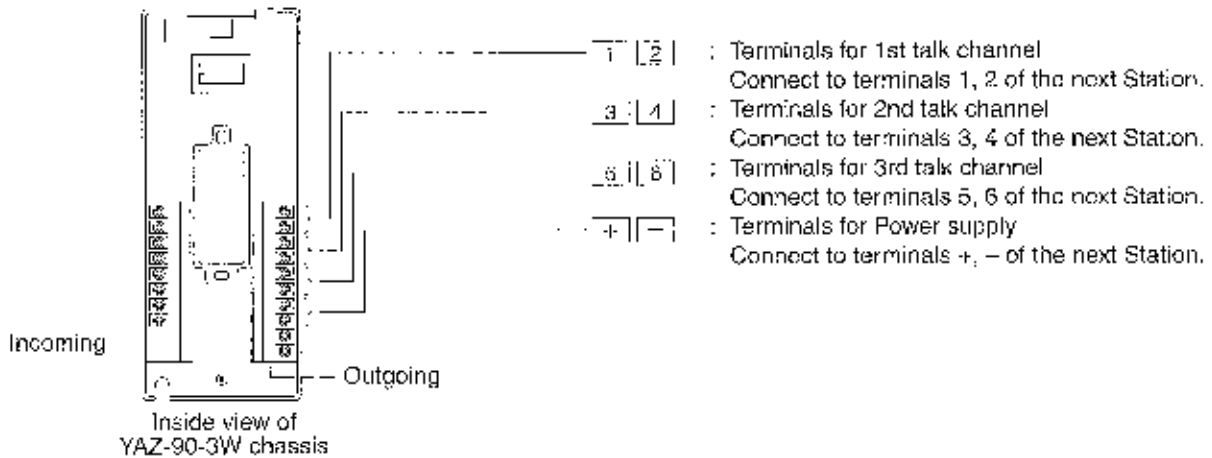

## SETTING YOUR STATION NUMBER

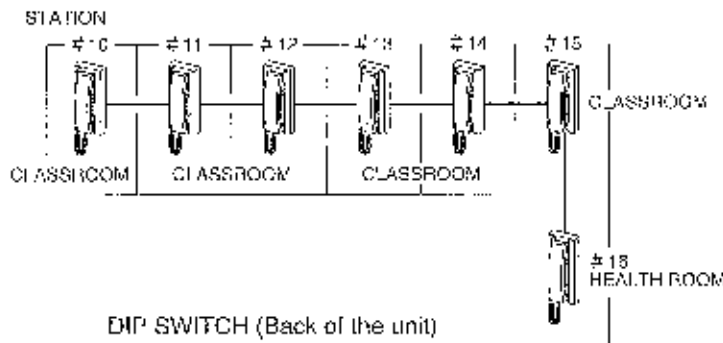

DIP SWITCH (Back of the unit)

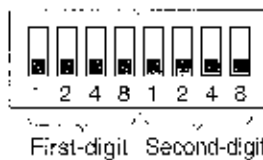

### STEP #1

- Assign a Station number from 10 through 99.
- The YAZ-90-3W system does not require central exchange unit and, therefore, assigning Station number must be done on each Station.
- The YAZ-90-3W Station may have any number from 10 through 99 according to users' convenience.
- Be sure to assign a Station number for every installed Station otherwise that Station would not be able to receive calls.
- Do not assign a same number to more than one Station.

### STEP #2

On the DIP SWITCH section (back of the unit), locate the switches to verify the STATION number for the station.

**Example; STATION #12**

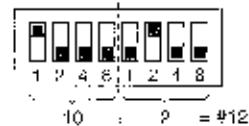

## STATION NUMBER CARD

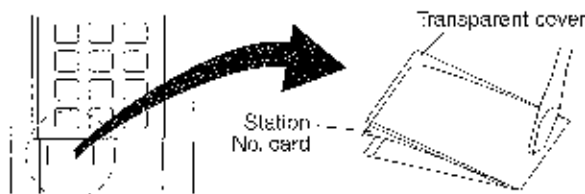

- Using the minus-head screwdriver, push either end of the transparent cover.
- Fill in your Station number programmed on the card.

## 4 WIRING

### 1. Cable

Use twisted pair cable, not straight conductors. (Type CPEV, shielded)

- (1) YAZ-90-3W station employs such components as CPU(microprocessor) and IC chips. Twisted pair cable must be used to prevent the unit from being interfered by line inductive noises generated by the surrounding electrical appliances and from crosstalk and malfunction caused by cable conductors themselves.
- (2) Keep at least 30cm (1') away from other cable, like AC power lines, paging speaker lines or telephone lines, or provide metal conduit for running cable.

### 2. Wiring distance

The total wiring distance should not exceed 2.9Km (1.8 mile) with 0.8mm dia. cable (20AWG).  
( $l_1 + l_2 + l_3 + \dots + l_9 + l_{10}$  in the below illustration)

**Note;** The line loop resistance should not exceed 200 Ohm for communication line between the farthest stations (Stations 5 and 10) in the system.

DIAMETER	∅0.5mm	∅0.65mm	∅0.8mm
DISTANCE	1,100m	1,900m	2,900m
AWG	24AWG	22AWG	20AWG
DISTANCE	0.7 mile	1.2 mile	1.8 mile

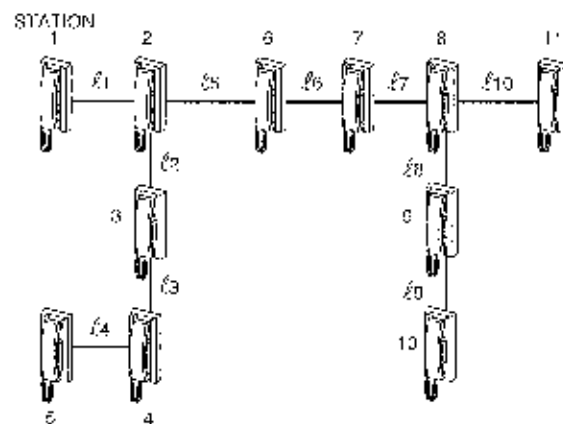

### 3. One power supply is required for every 30 Stations

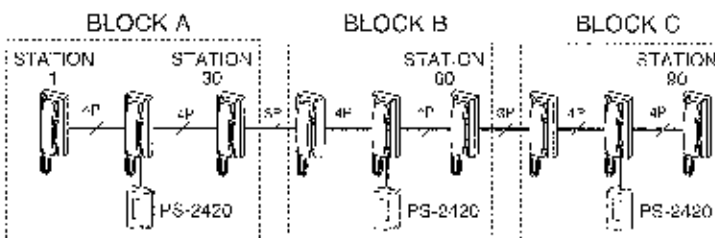

No. of YAZ-90-3W used	Power supply required	Location of Power supply
Up to 30 stations	1 pcs	Install a PS-2420 power supply in the center of each wiring block of 30 stations.
From 31 to 60 stations	2 pcs	
From 61 to 90 stations	3 pcs	

#### Notes;

- When power supply is installed in each Block: #1, 2 and 3 as shown in the left illustration, do not connect terminals +, - between each Block.
- The loop resistance of power supply line between PS-2420 power supply and the farthest Station in each Block, should be less than 20 Ohm.
- When locating power supplies for each Block, count the paging adaptors as follows:
  - one YAW-RB single-zone paging adaptor as 5 x YAZ-90-3W Stations.

### 4. Installation location requirements

In general, observe the installation location requirements as stated in PRECAUTIONS section. When the YAZ system is installed outside the building, such as ski resort and/or between buildings, etc. the cable has to be buried under ground in metal conduit. Be sure not to run the cable in midair which can invite lightning surge and causes permanent damage to the YAZ system.

# 5 WIRING DIAGRAM

• YAZ-90-3W is a Parallel-wiring system, requiring up to 4-twisted pairs of conductors throughout the system.

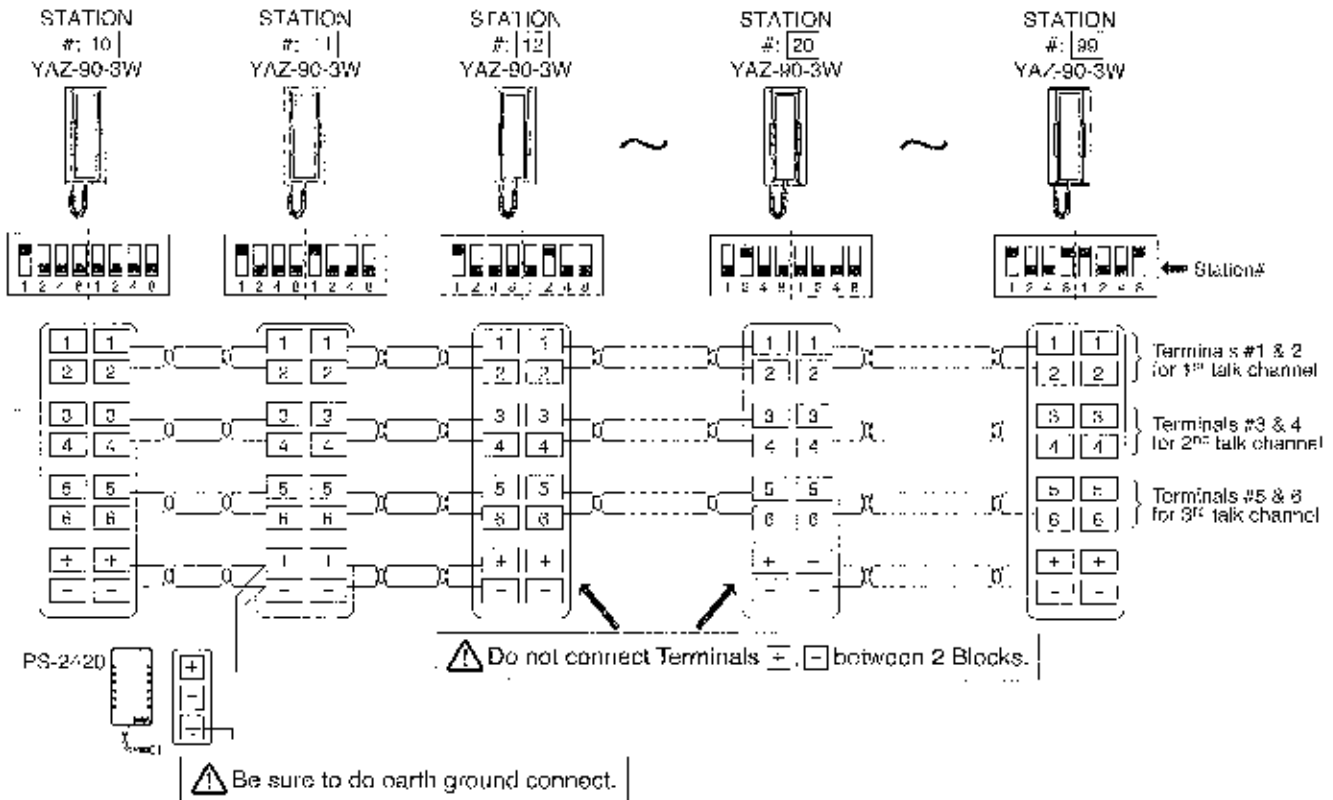

## IMPORTANT WIRING INSTRUCTIONS

### WIRING

- Use twisted pair cable.
- Connect 1<sup>st</sup> twisted pair to terminals 1 and 2, 2<sup>nd</sup> twisted pair to terminals 3 and 4, 3<sup>rd</sup> twisted pair to 5 and 6 and 4<sup>th</sup> twisted pair to + and -. Do not cross wires.
- Even if you have extra wires, do not use them for talk line. Do not connect two or more wires to each number terminal.

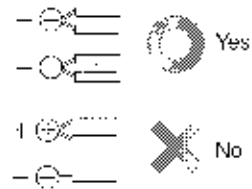

### PS-2420 POWER SUPPLY CONNECTION

- One PS-2420 power supply is required for every 30 Stations.
- Each PS-2420 power supply must be located near center of each 30 Station group.
- The + and - lines must not be installed between each groups, i.e. If the system includes 60 Stations, the 1<sup>st</sup> PS-2420 should be connected to Station No.25 and the 2<sup>nd</sup> PS-2420 to Station No.55. Do not connect terminals + and - between Stations Nos.39 and 40.
- If you have extra wires, it may be used for wiring to +, - lines (never for talk lines). It is important, however, the line resistance on +, - lines is equal as shown in the drawing.

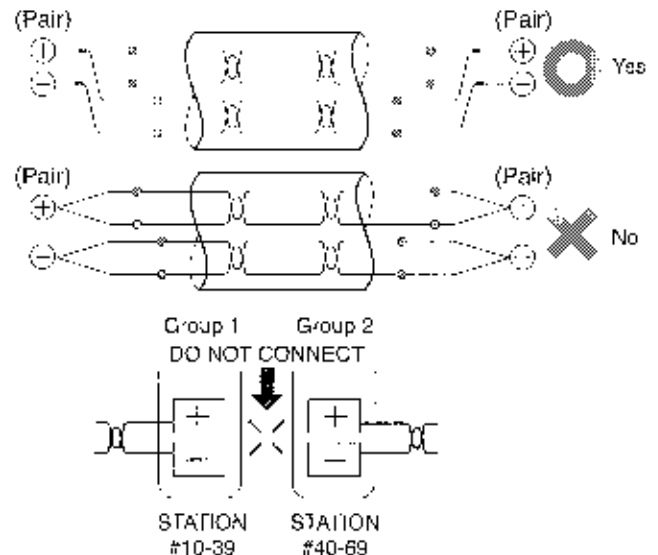

## 6 MOUNTING

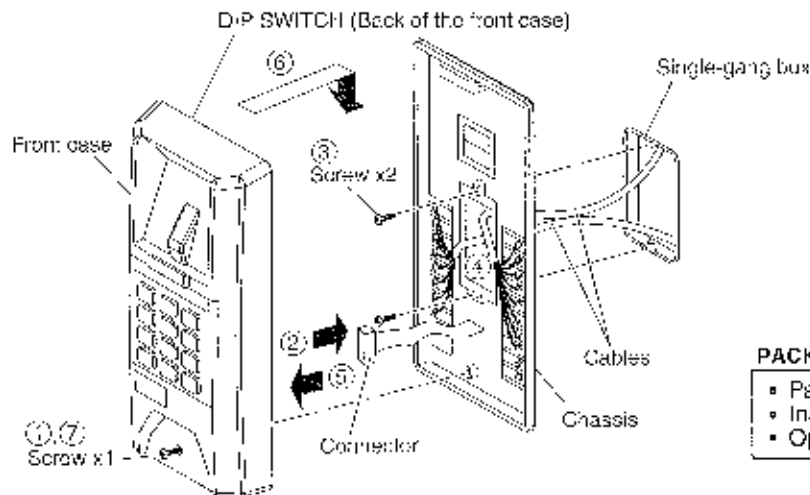

### PACKAGE CONTENTS

- Packet of screws
- Installation & Operation Manual
- Operation & Directory sheet

YAZ-90-3W unit is designed for wall-mounting and the terminal section is located on inside of the chassis. Be sure to run cable through conduit or in the wall and mount the YAZ-90-3W unit onto single-gang box.

### Wall-mounting

1. Loosen a screw and separate the front case from chassis.
2. Unplug connector from the receptacle on back of front case.
3. Attach chassis onto single-gang box.
4. Connect wires to the terminals on the chassis attached.
5. Attach connector to the receptacle again.
6. Hook front case to chassis at its top.
7. Attach front case to chassis by the screw.

# 7 OPERATIONS

## SELF-CHECK

1. Pick up handset and dial tone is heard.
2. Press number buttons [2], [1], [3], [7] and [9]. Your station is placed in self-check mode. Busy tone means your operation is void. Try again.
3. Depress and hold down either number button [1], [2] or [3] to check the corresponding talk channel.
4. A continuous tone means your station is operative. An intermittent tone means your station is non-operative.

## STATION CALLING

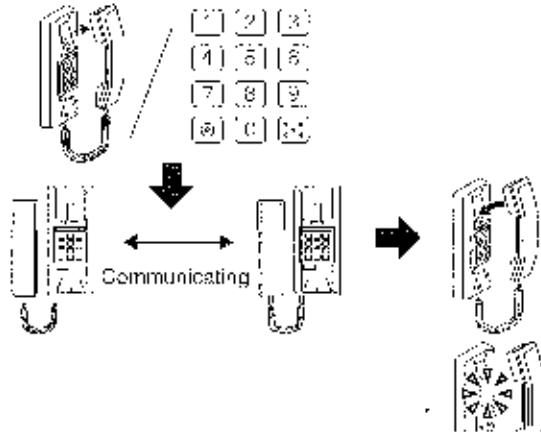

1. Pick up handset.
2. Press two dial buttons of station to talk with (example: [1], [0] for Station #10).
3. Call by voice, holding down PAGE button in handset.
4. Communicate. At the end, replace handset.

### *Tremolo tone*

Talk as on a telephone after the called station replies.

### *Busy tone*

The station is in communication.

Hang up and call later.

OR

Press [0] button. Camp-on busy is set, and hang up. (The LED flashes to indicate)

## RECEIVING

Incoming call is annunciated by either tremolo or voice. Lift handset and reply.

**Note:** Tremolo cal. tone times out in approx. 35 sec.

## CALL TRANSFER

When you transfer your call with one station to another; Press [0] button and a Station No. you will transfer the call to. Hold on until the Station replies.

After talking, hang up.

OR

Press [0] and the Station No.

INTERMITTENT tone means your transfer is being completed. You may hang up.

## COMMUNICATION AMONG 3 STATIONS (or Call transfer)

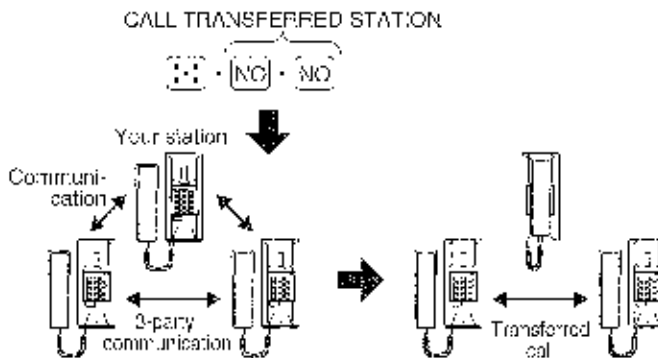

To have a third Station to join your present talking, press [0] button and Station No. to ring. When you hang up, call transfer is completed.

If your call will not be answered within approx. 18 seconds, it returns to initial two-party conversation.

## SECRETARY TRANSFER (Station transfer)

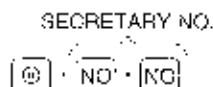

To have any of incoming calls to be transferred to your Secretary Station or any designated Station; Lift handset. Press [0] button and two digits of Secretary station. Replace handset. Indicator LED flashes on your Station. Hang up.

### *To clear:*

Press [0] and [0] buttons.

## PAGING TO A SINGLE ZONE (when YAW-RB is used)

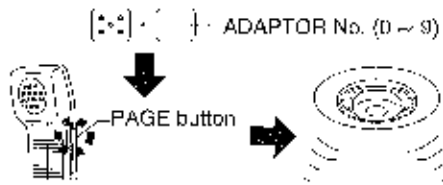

Lift handset. Press [PAGE] button.  
Press a number button 0 to 9 assigned for YAW-RB.  
Transmit your message while holding down PAGE button.  
Replace handset.

## 8 TECHNICAL PRECAUTIONS

### Operating temperature

The YAZ-90-3W is rated to operate between temperatures 0°C ~ +40°C (32°F ~ 104°F).

### Cleaning

Clean the YAZ-90-3W equipment with a soft cloth dampened with neutral household cleanser. Never use any abrasive cleaner or cloth.

At the end of communication, be sure to replace handset on cradle properly. If not, the YAZ-90-3W will not receive a call.

## 9 SPECIFICATIONS

- Power source : DC 24V. Use a PS-2420 power supply(ies).
- Current consumption : Maximum 80mA (per station). Standby: 25mA.
- Communication : Simultaneous with handset.
- Talk channel : Maximum 3 channels.
- Station selection : 2-digit dial (No.10 ~ 99).
- Wiring : 2-twisted pairs in parallel for 1 channel (1-2, + - - -).  
3-twisted pairs in parallel for 2 channels (1-2, 3-4, + - - -).  
4-twisted pairs in parallel for 3 channels (1-2, 3-4, 5-6, + - - -).
- Wiring distance : 2.9Km with 0.8mm dia. (1.8 mile with 20AWG) in total.
- Permitted line resistance : Less than 200 Ohm Loop for communication line.  
Less than 20 Ohm Loop for power line.

This equipment has been tested and found to comply with the limits for a Class B digital device, pursuant to Part 15 of the FCC Rules. These limits are designed to provide reasonable protection against harmful interference in a residential installation. This equipment generates, uses, and can radiate radio frequency energy, and if not installed and used in accordance with the instructions, may cause harmful interference to radio communications. However, there is no guarantee that interference will not occur in a particular installation. If this equipment does cause harmful interference to radio or television reception, which can be determined by turning the equipment off and on, the user is encouraged to try to correct the interference by one or more of the following measures:  
• Reorient or relocate the receiving antenna. • Connect the equipment into an outlet on a circuit different from that to which the receiver is connected. • Increase the separation between the equipment and receiver. • Consult the dealer or an experienced radio/TV technician for help.

### WARRANTY

Aiphone warrants its products to be free from defects of material and workmanship under normal use and service for a period of one year after delivery to the ultimate user and will repair free of charge or replace at no charge, should it become defective upon which examination shall disclose to be defective and under warranty. Aiphone reserves unto itself the sole right to make the final decision whether there is a defect in materials and/or workmanship; and whether or not the product is within the warranty.

This warranty shall not apply to any Aiphone product which has been subject to misuse, neglect, accident, or to use in violation of instructions furnished, nor extended to units which have been repaired or altered outside of the factory.

This warranty does not cover batteries or damage caused by batteries used in connection with the unit.

This warranty covers bench repairs only, and any repairs must be made at the shop or place designated in writing by Aiphone.

Aiphone will not be responsible for any costs incurred involving on site service calls.

AIPHONE CO., LTD., NAGOYA, JAPAN  
AIPHONE CORPORATION, BELLEVUE, WA, USA  
AIPHONE S.A., WISSOUS, CEDEX, FRANCE

 **AIPHONE**<sup>®</sup>  
Providing Peace of Mind  
<http://www.aiphone.com/>