



ACCESS CONTROL PRODUCTS



| PART | DESCRIPTION | Ex Brisbane |
|-------------|--|-------------|
| SQ1300 | 100 X 100 X 1270MM HIGH SQUARE BARRIER BOLLARD DURAGAL POST EPOXY ZINC POWDER COAT PRIMED AND POLYESTER POWDER TOP COAT | |
| SR1600 | 150 X 50 X 1600MM HIGH RECTANGULAR BOLLARD DURAGAL POST EPOXY ZINC POWDER COAT PRIMED AND POLYESTER POWDER TOP COAT | |
| SEQ1 | 75 X 75 X 1170 MM HIGH SINGLE READER / INTERCOM BOLLARD DURAGAL POST EPOXY ZINC POWDER COAT PRIMED AND POLYESTER POWDER TOP COAT | |
| SEQ2 | 75 X 75 X 1170 & 2120 MM HIGH DUAL READER / INTERCOM BOLLARD DURAGAL POST EPOXY ZINC POWDER COAT PRIMED AND POLYESTER POWDER TOP COAT | |
| SEQTR | 75 X 75 X 2120 MM HIGH SINGLE READER SUIT TRUCK / INTERCOM BOLLARD DURAGAL POST EPOXY ZINC PRIMED AND POLYESTER POWDER TOP COAT | |
| SEW300 | 300MM PROJECTION WALL MOUNT READER / INTERCOM ARM CABLE PATH THROUGH REAR AND UNDERSIDE OF ARM | |
| SEW600 | 600MM PROJECTION WALL MOUNT READER / INTERCOM ARM CABLE PATH THROUGH REAR AND UNDERSIDE OF ARM | |
| SERS2013 | 200H X 130W RAIN SHIELD SUIT SEQ, SER & SEW SERIES ARMS AND BOLLARDS 25MM SPACE BEHIND ALUMINIUM MOUNTING PANEL. | |
| SERSL2013XD | 200H X 130W RAIN SHIELD SUIT SEQ, SER & SEW SERIES ARMS AND BOLLARDS 25MM SPACE BEHIND ALUMIC MOUNTING PANEL. AND ADITTIONAL SHIELD PROJECTION | |
| SERS2013XD | 200H X 130W RAIN SHIELD SUIT SEQ, SER & SEW SERIES ARMS AND BOLLARDS 68MM SPACE BEHIND ALUMINIUM MOUNTING PANEL. | |
| SERH3618 | 360H X 180W RAIN HOOD 8MM POLYETHELENE BLACK BOARD MOUNTING PANEL 60MM SPACE BEHIND PANEL + 8MM POLYBOARD THICKNESS | |
| SERSL3618 | 360H X 180W RAIN HOOD ALUM MOUNTING PANEL 25MM SPACE BEHIND PANEL | |
| SERS3618 | 360H X 180W RAIN HOOD ALUM MOUNTING PANEL 60MM SPACE BEHIND PANEL | |
| SERH3634 | 360H X 340W RAIN HOOD 8MM POLYETHELENE BLACK BOARD MOUNTING PANEL 60MM SPACE BEHIND PANEL + 8MM POLYBOARD THICKNESS | |
| SERSL3634 | 360H X 340W RAIN HOOD ALUM MOUNTING PANEL 25MM SPACE BEHIND PANEL | |
| SERS3634 | 360H X 340W RAIN HOOD ALUM MOUNTING PANEL 60MM SPACE BEHIND PANEL | |
| SERH4718 | 470H X 180W RAIN HOOD 8MM POLYETHELENE BLACK BOARD MOUNTING PANEL 80MM SPACE BEHIND PANEL + 8MM POLYBOARD THICKNESS | |
| SERSL4718 | 470H X 180W RAIN HOOD ALUM MOUNTING PANEL 25MM SPACE BEHIND PANEL | |
| SERS4718 | 470H X 180W RAIN HOOD ALUM MOUNTING PANEL 80MM SPACE BEHIND PANEL | |
| SERH3643 | 360H X 430W RAIN HOOD 8MM POLYETHELENE BLACK BOARD MOUNTING PANEL 60MM SPACE BEHIND PANEL + 8MM POLYBOARD THICKNESS | |
| SERS3643 | 360H X 430W RAIN HOOD ALUM MOUNTING PANEL 60MM SPACE BEHIND PANEL | |
| SERHGT | 463H X 180W R/HOOD SUIT AIPHONE GT-DM & GT-4F SUPPLIED WITH 2 X BLACK POWDER COATED MOUNTING PLATES. | |
| SERHGTDMSS | 316 GRADE STAINLESS STEEL SURFACE MOUNT ENCLOSURE SUIT AIPHONE GT DMB N | |
| XSE150 | MOUNT EXTENDER 150MM SUIT SEQ, SER & SEW SERIES ARMS AND BOLLARDS DURAGAL PIPE SECTION EPOXY ZINC POWDER COAT PRIMED AND TOP COATED | |
| XSE300 | MOUNT EXTENDER 300MM SUIT SEQ, SER & SEW SERIES ARMS AND BOLLARDS DURAGAL PIPE SECTION EPOXY ZINC POWDER COAT PRIMED AND TOP COATED | |
| SEMP2013 | 200H X 130W MOUNTING PLATE SUIT SEQ, SER & SEW SERIES ARMS AND BOLLARDS | |
| NOTE | SPECIFY "Y" FOR YELLOW & B FOR BLACK POWDER COAT FINISH IE: SEQ1Y FOR SINGLE YELLOW BOLLARD | |

SEQ & SER SERIES INTERCOM AND READER BOLLARDS & RAINHOODS 2022 - 2023

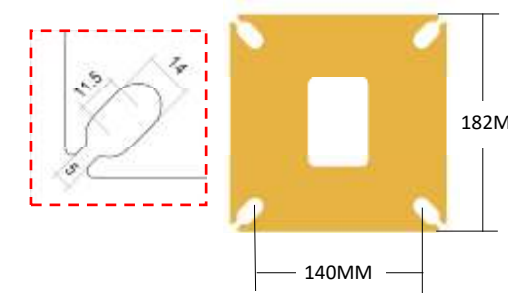
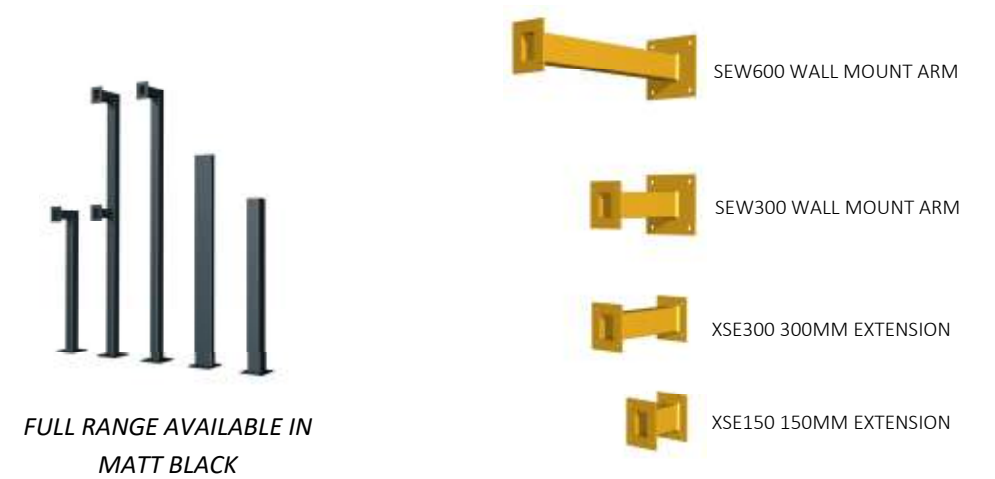
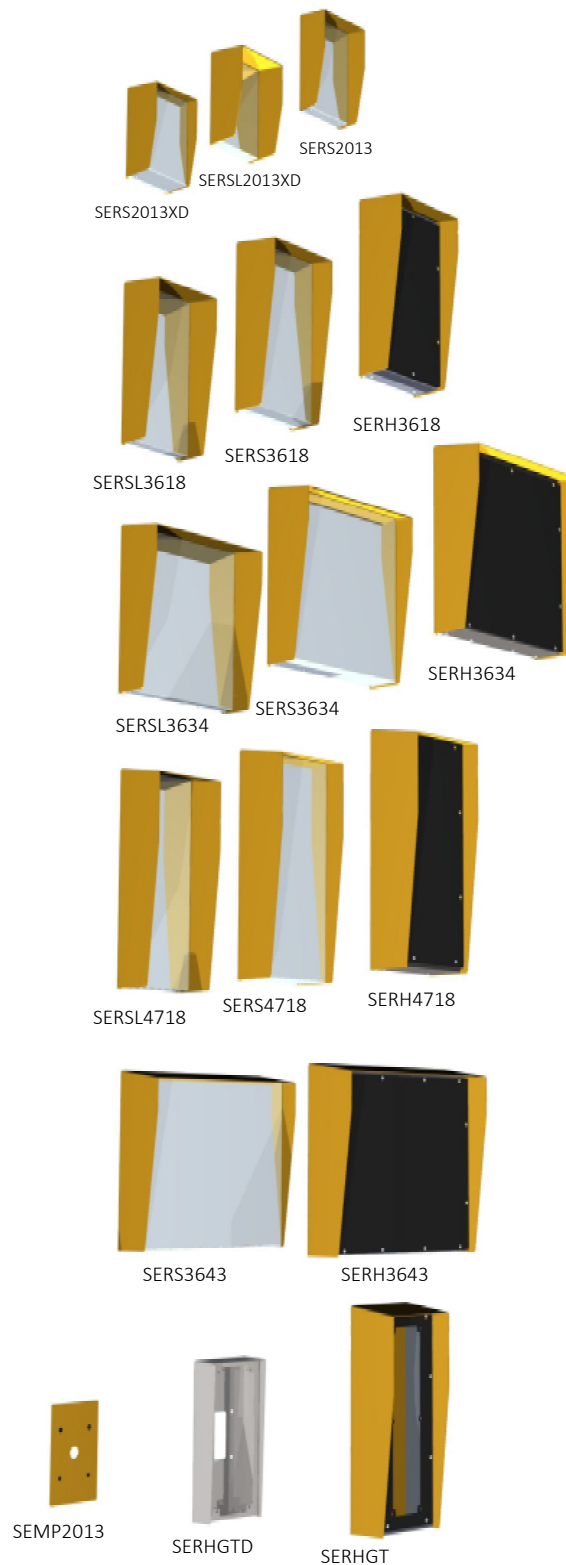

WALL AND BASE PLATE DIMENSIONS FOR:
 SEQ1 / SEQ2 / SEQTR / SER1 / SER2 / SQ1300 / SEW300 /
 SEW600 182 X 182MM SQUARE (MOUNTING HOLES
 14MM DIAMETER 140MM BETWEEN CENTERS)
 OPEN OBOURND MOUNTING HOLE IN BASE PLATE IS
 BEING PHASED IN DURING 2022

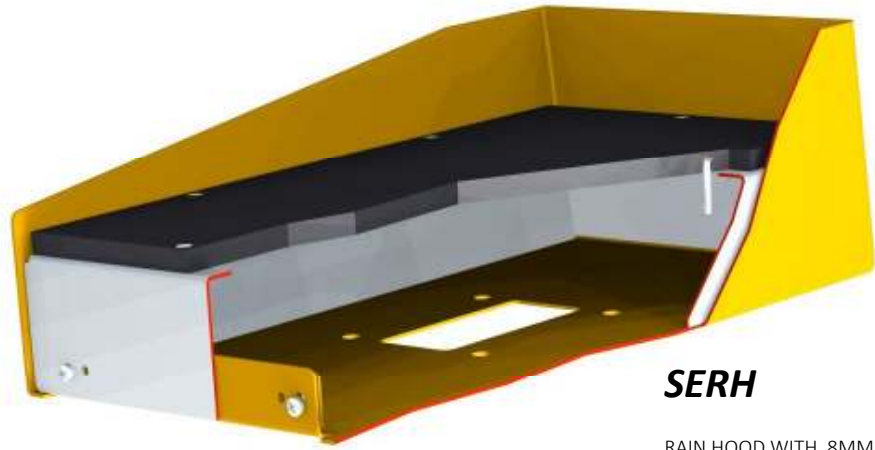

SERH

RAIN HOOD WITH 8MM POLYETHELENE MOUNTING PANEL. A NON CONDUCTIVE BACK PLANE EASILY CUT AND DRILLED.

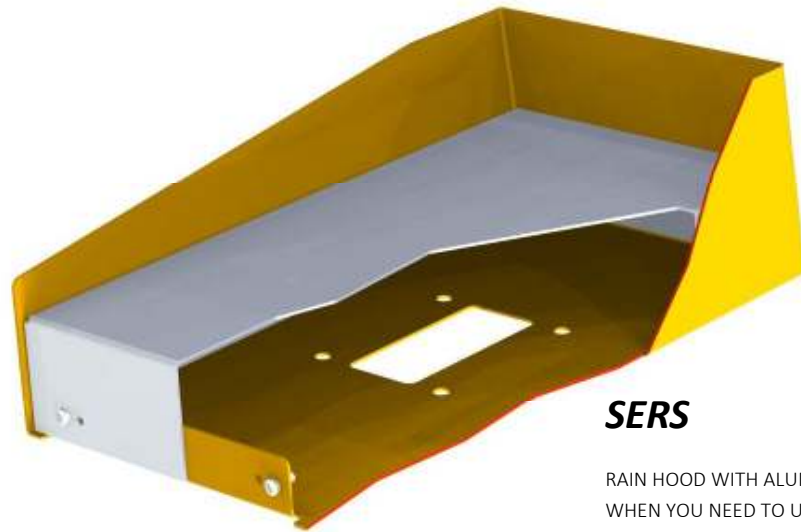

SERS

RAIN HOOD WITH ALUMINIUM MOUNTING PANEL. IDEAL WHEN YOU NEED TO USE THE FULL HEIGHT AND WIDTH OF THE PANEL AND NOT HAVE TO CONSIDER THE FRONT PANEL FASTENERS AND FRAME BEHIND.



SERSL

RAIN HOOD WITH ALUMINIUM 25MM DEEP MOUNTING PANEL. SUITABLE FOR SURFACE MOUNT KEYPADS INTERCOMS AND READERS.



SERSL4718Y

ALL SERSL MODELS SUITABLE FOR SURFACE MOUNT KEYPADS INTERCOMS AND READERS. SHOWN WITH 1 X HIKVISION ACW3 & 1 X ACW1



SEW600

SERH3618Y & SEW600Y 600MM PROJECTION WALL MOUNT. ALSO AVAILABLE IN 300MM



XSE300

300MM MOUNTING EXTENSION FOR SEW, SER, SEQ ALSO AVAILABLE IN 150MM

SEQ & SER SERIES INTERCOM AND READER BOLLARDS & RAINHOODS 2022 - 2023

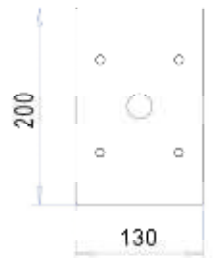
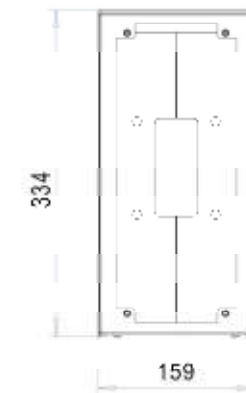
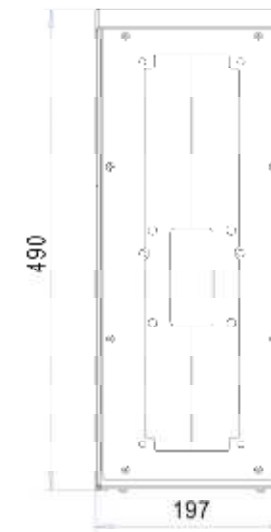
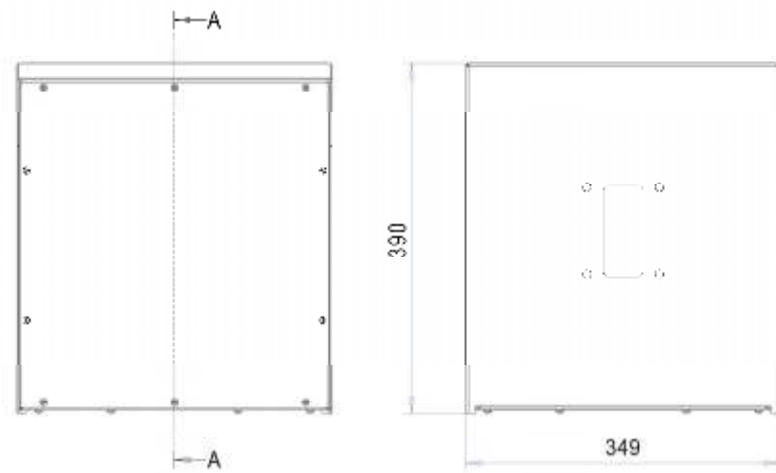
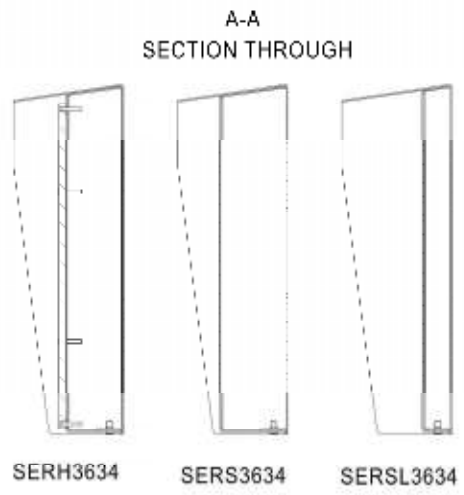
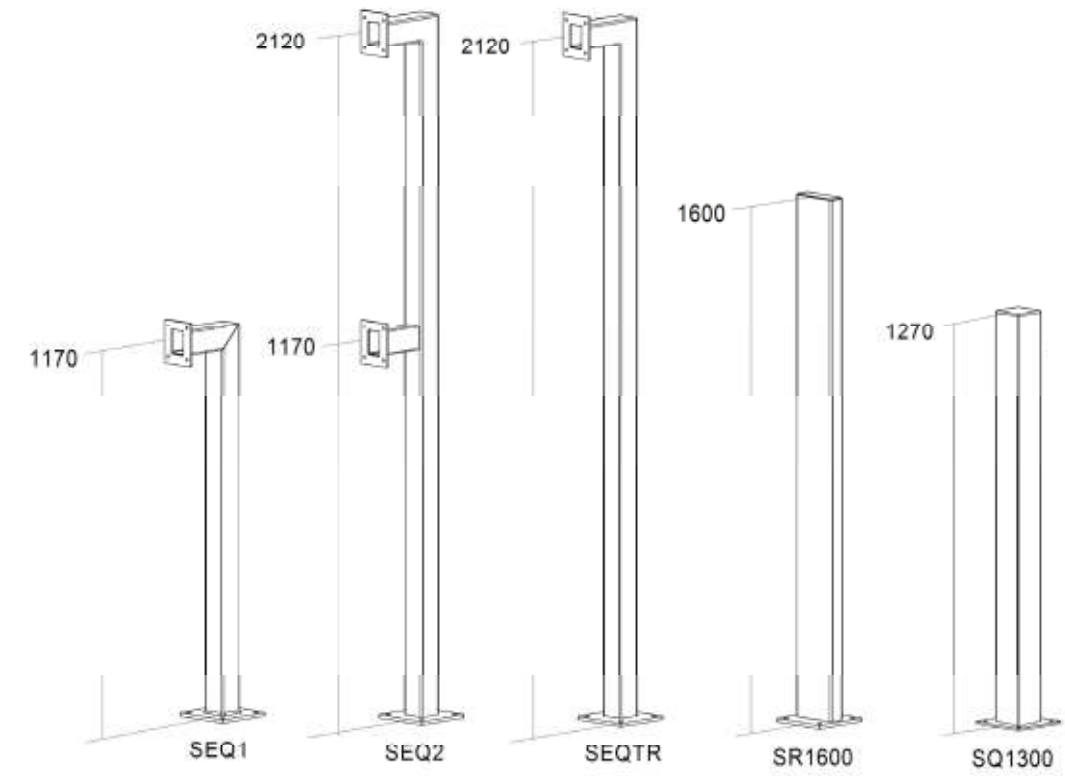
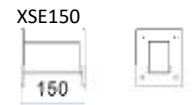
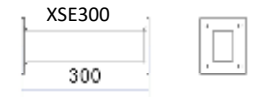
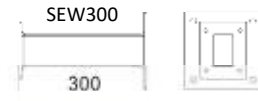
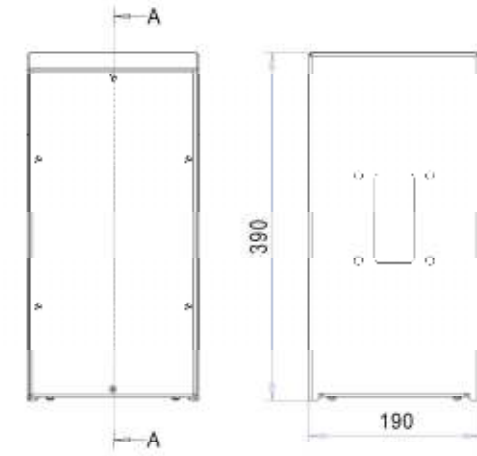
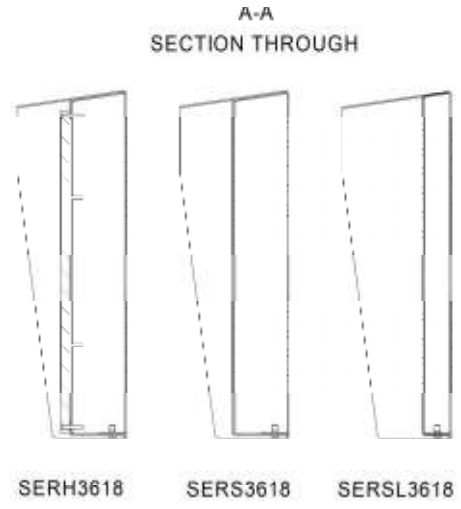
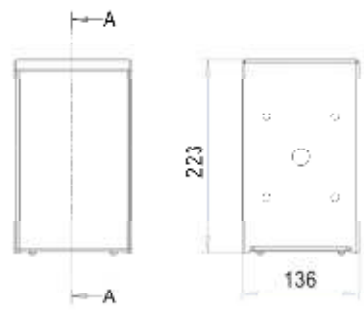
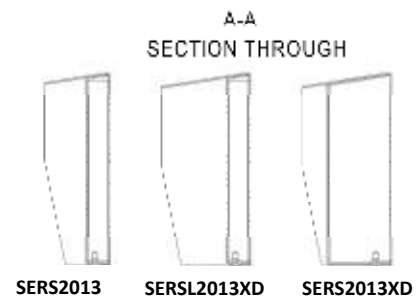

SERHGT

SERHGTMSS

SEMP2013

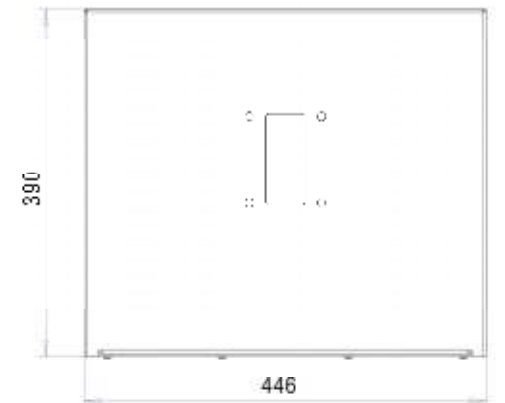
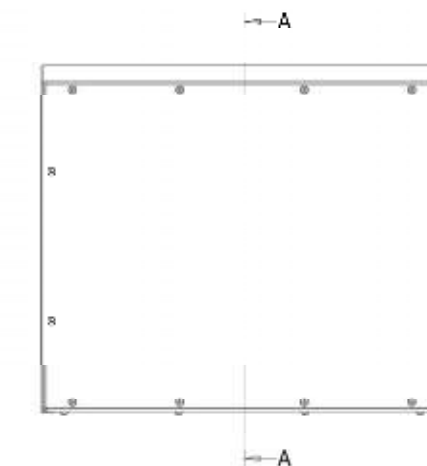
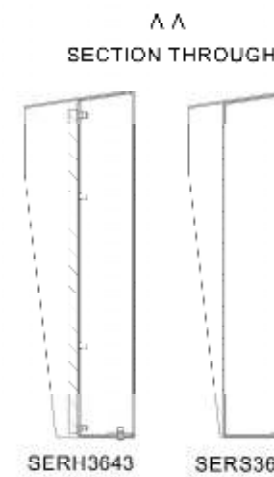
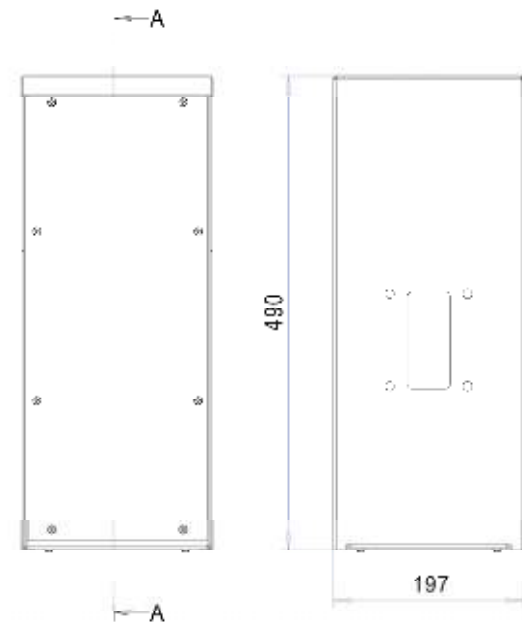
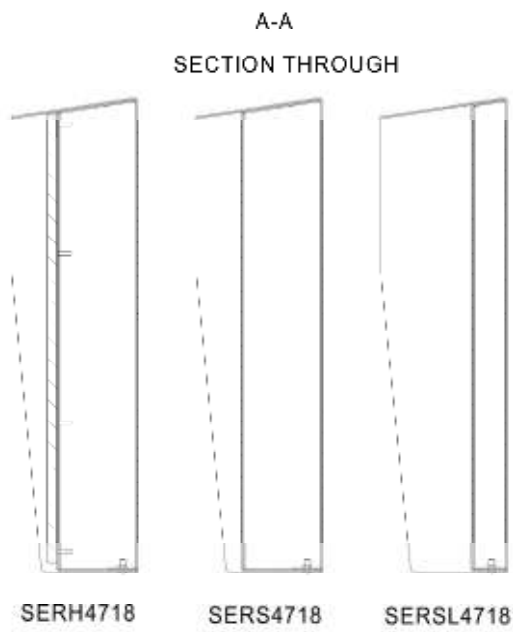

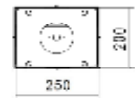
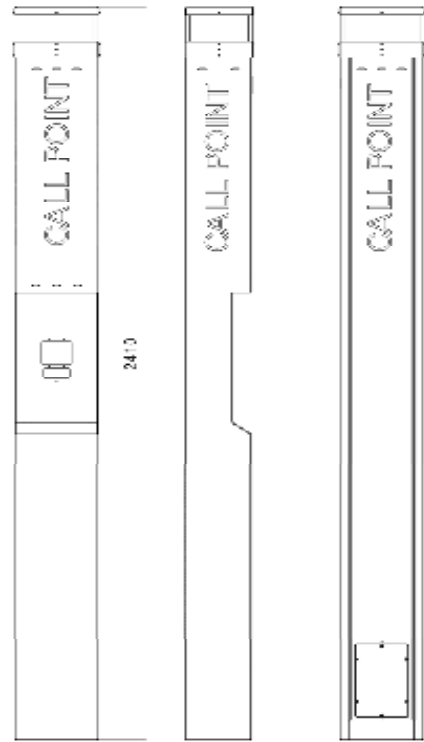

ECR2520

2410MM HIGH 250MM X 200MM INTERNALLY FIXED CALL POINT MANUFACTURED FROM 304 GRADE STAINLESS STEEL. POLYESTER POWDER COATED.

12-24V AC/DC STROBE LIGHTING SURROUNDED BY 6.0MM POLYCARBONATE LENS PLUS LED ILLUMINATION ABOVE INTERCOM/ KEYPAD

SUPPLIED STANDARD WITH CUSTOMISABLE STAINLESS STEEL MOUNTING PANEL

WHEN ORDERING SPECIFY:

1. POWDER COAT COLOUR
2. STROBE COLOUR & VOLTAGE
3. INTERCOM MODEL FOR CUSTOMISING MOUNT PLATE
4. TEXT REQUIRED FOR SIGNAGE

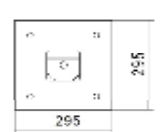
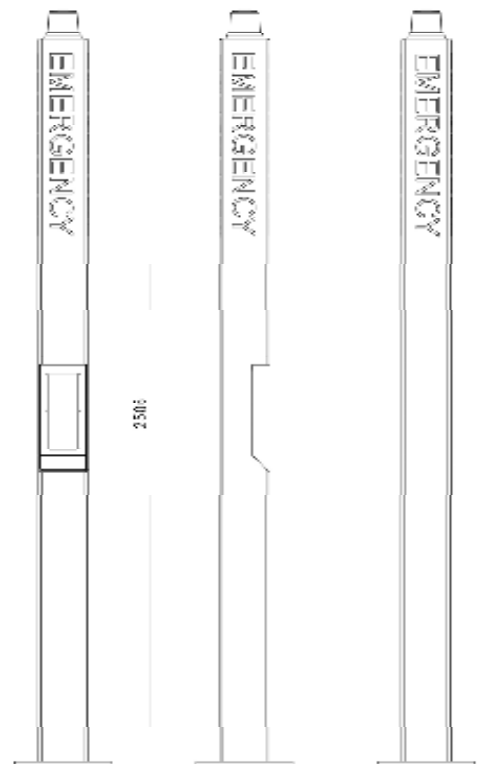

ECS1515

2506 MM HIGH 150 X 150 EXTERNALLY FIXED CALL POINT. MANUFACTURED FROM DURAGAL SHS ZINC POWDER COAT PRIMED AND TOP COATED.

12-24V AC/DC STROBE LIGHTING PLUS LED ILLUMINATION ABOVE INTERCOM/ KEYPAD

SUPPLIED STANDARD WITH CUSTOMISABLE STAINLESS STEEL MOUNTING PANEL

WHEN ORDERING SPECIFY:

1. POWDER COAT COLOUR
2. STROBE COLOUR & VOLTAGE
3. INTERCOM MODEL FOR CUSTOMISING MOUNT PLATE
4. TEXT REQUIRED FOR SIGNAGE

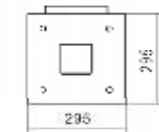
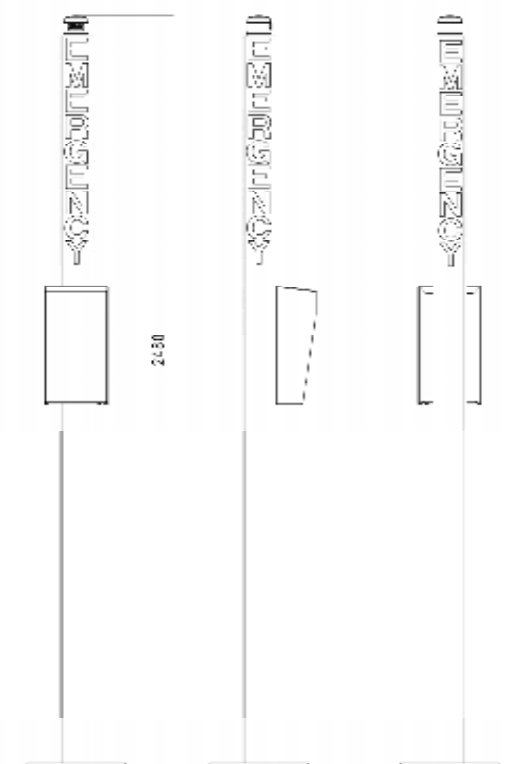

ECS1010

2480 MM HIGH 100 X 100 EXTERNALLY FIXED CALL POINT. MANUFACTURED FROM DURAGAL SHS ZINC POWDER COAT PRIMED AND TOP COATED.

DESIGNED TO MOUNT SECURITY DESIGN SERH/SERS & SERSL RAIN HOODS.

12-24V AC/DC STROBE LIGHTING SUPPLIED STANDARD WITH CUSTOMISABLE MOUNTING PANEL

WHEN ORDERING SPECIFY:

1. POWDER COAT COLOUR
2. STROBE COLOUR & VOLTAGE
3. RAIN HOOD MODEL AND INTERCOM DETAILS FOR CUSTOMISING MOUNT PLATE
4. TEXT REQUIRED FOR SIGNAGE

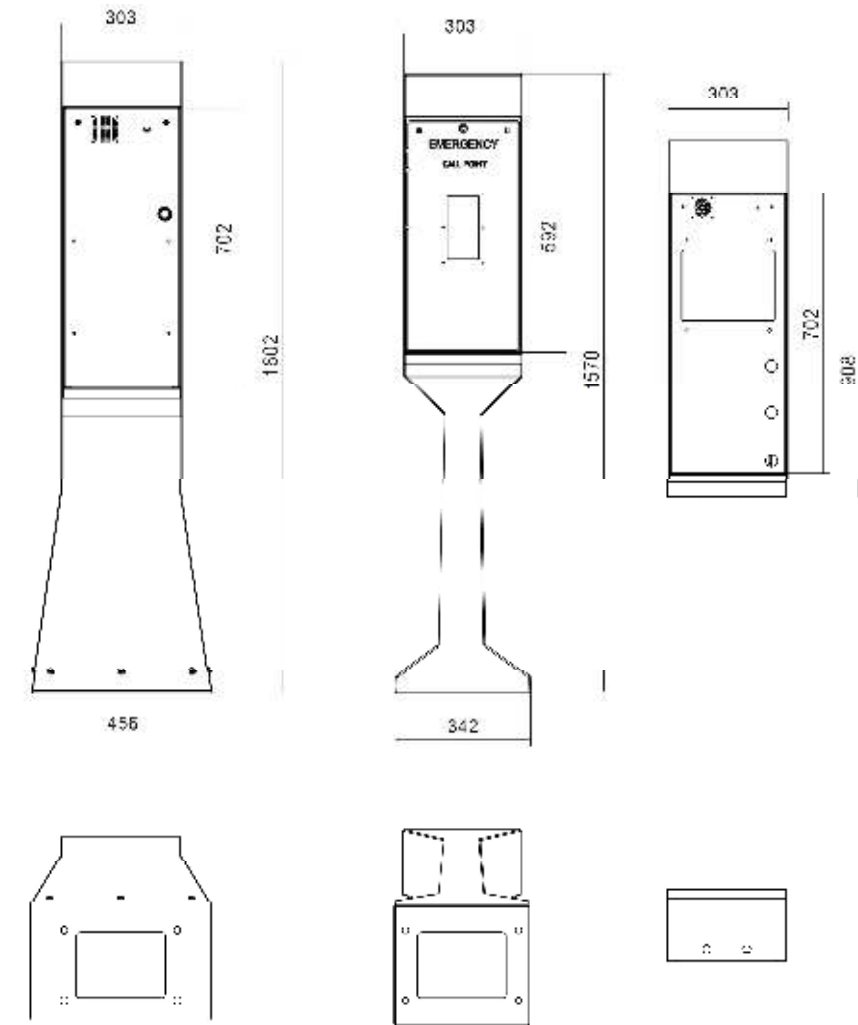

ECP PEDESTAL AND WALL MOUNT

MANUFACTURED FROM 304 GRADE STAINLESS STEEL WITH POLYESTER POWDER COAT FINISH.

HINGE DOWN FRONT PANEL IS RECESS MOUNTED LEAVING NO PRY BAR GAPS FOR VANDALS

STANDARD INCLUSIONS ARE CONCEALED HINGES, AND DUAL GAS STRUTS.

OPTIONS

1. ANTI GRAFITTI FINISH
2. CUSTOMISED INTERNAL GEAR TRAYS
3. MASTER KEY LOCKING.
4. VINYL GRAPHICS AS REQUIRED
5. 30MM DIAMETER ILLUMINATED STAINLESS PUSH BUTTONS FITTED WITH BRAILLE PINS

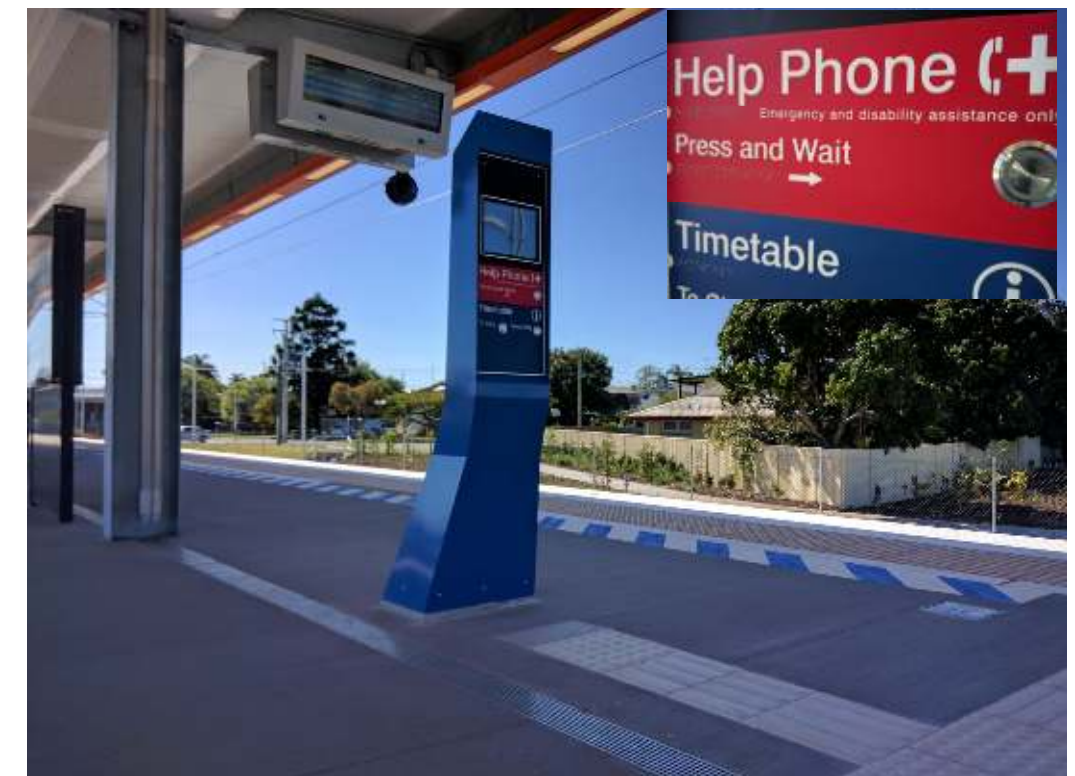

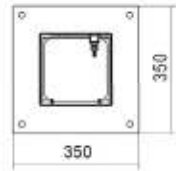
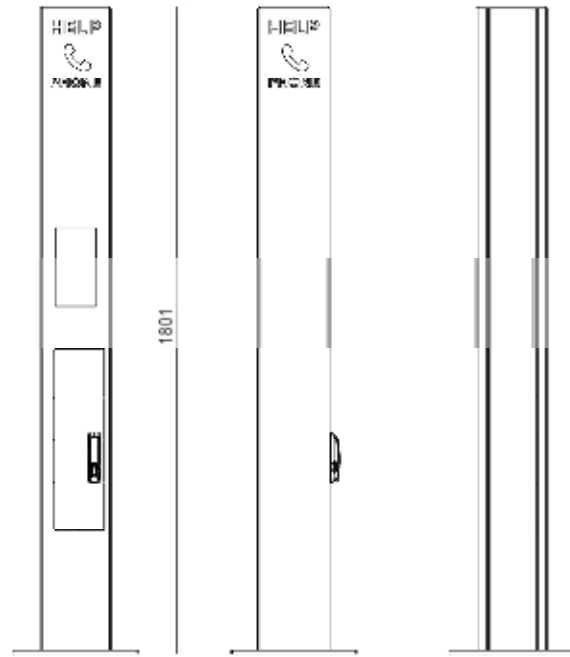

ECSP2020

1801 MM HIGH 200MM X 200MM
EXTERNALLY FIXED CALL POINT
MANUFACTURED FROM 304 GRADE
STAINLESS STEEL. POLYESTER POWDER
COATED.

HELP PHONE GRAPHICS AT THE TOP ARE ON
3 SIDES AND ARE FITTED WITH FLUSH
MOUNTED 6.0MM OPAL POLYCARBONATE
LENS BACKLIT LED

SUPPLIED STANDARD WITH CUSTOMISABLE
STAINLESS STEEL MOUNTING PANEL

WHEN ORDERING SPECIFY:

1. POWDER COAT COLOUR
2. INTERCOM MODEL FOR CUSTOMISING MOUNT PLATE
3. OPTION OF MASTER KEY LOCKABLE AND HINGED ACCESS DOOR OR ACCESS PANEL WITH COUNTERSUNK SECURITY FASTENERS



ECSP2020

FLUSH MOUNTED OPAL POLYCARBONATE
BACKLIT BY LED

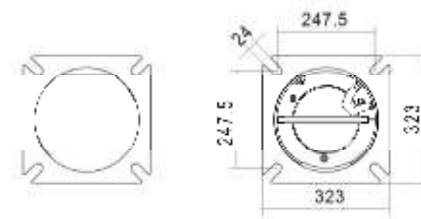
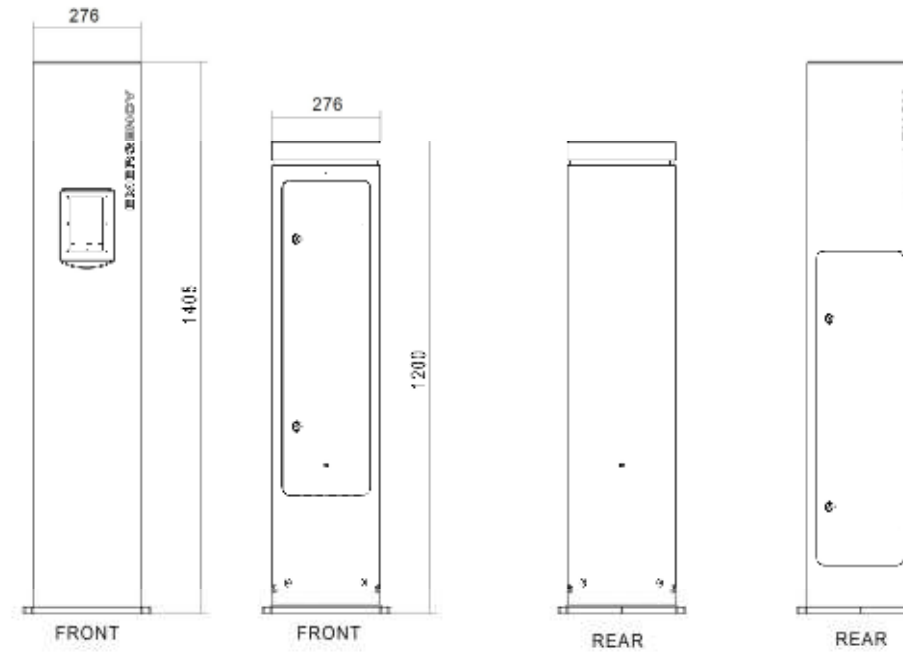

SDC021

SDC022

SDC021 & SDC022

KINGSFORD SMITH DRIVE PROJECT

SDC021 ECP INTERCOM PILLAR WITH BACK-
LIT OPAL POLYCARBONATE EMERGENCY
SIGNAGE

SDC022 LV & MAINS VOLTAGE
DISTRIBUTION PILLAR. ROTATING OUTER
CASE WITH SINGLE DOOR TO ACCESS LV
TRANSFORMERS AND 1&3 PHASE OUTLETS

MANUFACTURED FROM 316 GRADE
STAINLESS STEEL FINISHED WITH
FLUROPOLYMER POWDER COAT



SDC022



SDC021



SDC022



SDC022